

# SKYSTAR®

2018  NEW PRODUCT



## 广州市亮星电子灯光设备厂 Guangzhou Lightstar Electronic Lighting Equipment Factory

地址: 中国 广东 广州市天河区 龙洞迎龙大道234号龙山工业园E1栋2层  
电话: 86 020 87022418  
传真: 86 020 87023011  
移动电话: 13602863513  
公司主页: <http://www.lightskystar.com>  
<http://www.lightskystar.cn.alibaba.com/>  
公司邮箱: 623872311@qq.com  
vinca2004@126.com  
MSN: lightskystar@hotmail.com  
Skype: lightskystar  
QQ: 623872311 或 1725113820

Add: 2F., Building E-1, LongShan Industry Park, Yinglong RD.,  
Longdong, Tianhe District, Guangzhou China.

Web site: <http://www.lightskystar.com>  
<http://www.lightskystar.cn.alibaba.com>

Email: [vinca2004@126.com](mailto:vinca2004@126.com)  
MSN: [lightskystar@hotmail.com](mailto:lightskystar@hotmail.com)  
Skype: lightskystar  
QQ: 1725113820  
Tel: 8620-87022418  
Fax: 8620-87023011  
cellphone: +86 13609702481( Niki )

[HTTP://WWW.LIGHTSKYSTAR.COM](http://www.lightskystar.com)

# 企业简介

## Enterprise Profile



### 亮星灯光一闪亮舞台!

广州市亮星电子灯光设备厂专业开发设计、生产销售舞台灯光产品,成立于1999年,是中国广东演艺设备行业商会会员、著名网站阿里巴巴诚信通优质供应商,并获百度认证,也是慧聪网和中国制造网的注册会员。亮星一直秉承着质量优、性价比高的理念,给客户专业标准的舞台灯光产品和售前、售后服务。我们的诚信、品质及高性价比的产品均获得客户与业界的认可和好评,让我们拥有不少销量稳定的客户,好的口碑带来更多客户的支持和信赖!

SKYSTAR 是我厂注册多年的自主品牌,深受客户喜欢,主要生产:光束灯、LED摇头灯、LED追光灯、LED帕灯、LED火焰灯等.....其中led追光灯和led火焰灯更是我厂自主开发和研制的产品!)

我们为客户提供加工定制服务,产品远销到中国大部分地区及东南亚、中东、澳洲、新西兰、美洲和非洲等地。欢迎业界朋友莅临参观指导和进行业务洽谈。希望我们的产品就像天空中的星星一样,照亮你们的舞台!

### SKYSTAR Lights,light up the stage of world!

Guangzhou Lightstar Electronic Lighting Equipment Factory is specialized in the development, design, production and sales of lighting products, was founded in 1999. Our factory was the Member of CETA and SCEE ( Industry Association Of Entertainment Equipment of China), Alibaba (famous website ) quality suppliers, authenticated by Baidu, we also was registered member of the HC and Made-in-China. We have been adhering to the idea of excellent quality, high performance, and provide a professional standard of stage lighting products and pre-sales, after-sales service. Our integrity, good quality and reasonable price have access to customer and industry recognition and praise, let us have a lot of stable customers, good reputation brings more people's support and trust!

SKYSTAR is our registered brand for many years, main products are beam moving head, led moving head lights, led follow spot lights, led par lights, led flame lights and so on. (LED follow spot lights and LED flame lights is our own independent research and development products!)

We provide customized services, products are saled to most parts of China, and export to Southeast Asia, the Middle East, Oceania, Americas, Africa and other country.

Welcome all friends to visit and conduct business negotiations with us. Because of you, SKYSTAR will more and more brighter on your stage!

# 企业概况

## Enterprise Profile

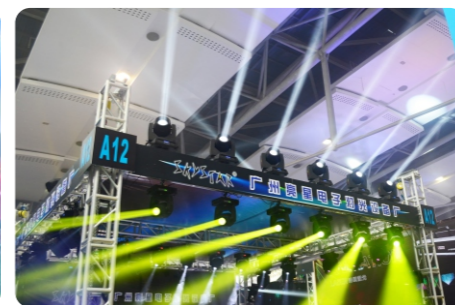
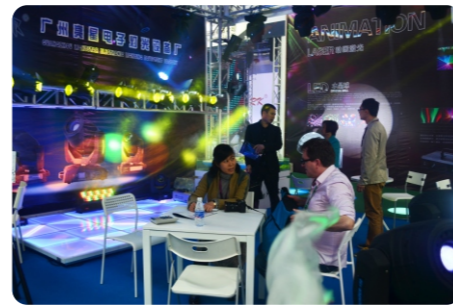

SKYSTAR®  
亮星灯光

20R Standard Beam Moving Head Lights-high light

SR-440



◎技术参数:

灯泡: OSRAM 20R 440W  
 功耗: 100V-230V 50HZ 550VA  
 光学器件: 高效率镜头组, 变焦0°至2°  
 电子聚焦: 20米处, 180000LUX  
 通道模式: 16个两种国际标准DMX512通道  
 水平扫描: 540° (16bit精度扫描)  
 垂直扫描: 280° (16bit精度扫描)  
 色片盘: 14个色片+白光,  
 带双向旋转的彩虹效果  
 旋转图案盘: 13个图案片+白圆,  
 带图案抖动和图案任意定位功能  
 棱镜盘: 两个可旋转棱镜, 一个圆形48棱镜,  
 一个16棱镜, 可叠加。可正反方向  
 旋转, 并具有棱镜定位功能。  
 频闪: 双铡刀频闪频率最高可以13次每秒,  
 并可选择随机频闪及脉冲频闪  
 调光: 0%~100%线性调光  
 雾化: 0%~100%线性雾化  
 电子整流器: 使产品重量更轻, 亮度更强,  
 灯泡更稳定, 更环保, 更节能  
 开关电源: AC100~240V, 50/60HZ  
 灯体尺寸: 长400×宽320×高650 (mm)  
 包装尺寸: 长470×宽450×高680 (mm)  
 净重: 21公斤  
 毛重: 24公斤

◎ TECHNICAL PARAMETER:

BULB: OSRAM 20R 440W  
 POWER CONSUMPTION: 100V-230 V 50 HZ 550 VA  
 OPTICAL DEVICE: high efficiency lens group, 0° -2° zoom  
 ELECTRONIC FOCUS: 20 meters, 180000 LUX  
 CHANNEL MODE: 16 standard DMX512 channel  
 LEVEL SCANNING: 540(16 bit precision scan)  
 VERTICAL SCAN: 280(16 bit precision scan)  
 COLOR WHEEL: 14color and white light  
 with two-way rotating and rainbow effect  
 ROTATING GOBO WHEEL: 13 gobos and white circle  
 with design jitter and arbitrary positioning function  
 PRISM: two prism, 48-facet circular prism , 16-facet linear  
 prism, with superposition, positive and negative  
 rotation and prism location function.  
 SHUT: Double pole shut up to 13 times per second,  
 random shut and pulse shut can be choosed  
 DIMMER: 0% ~ 100% linear dimmer  
 FROST: 0% ~ 100% linear frost  
 Electronic ballast : make the product more light and bright.  
 Lamp more stable environmental protection and  
 more energy saving  
 SWITCHING POWER SUPPLY : AC100 ~ 240 V, 50/60 HZ  
 FIXTURE DIMENSION: L400×W320×H650(mm)  
 PACKING DIMENSION: L470×W450×H680(mm)  
 NET WEIGHT: 21KG  
 GROSS WEIGHT: 24KG

SR-440 >>光效图

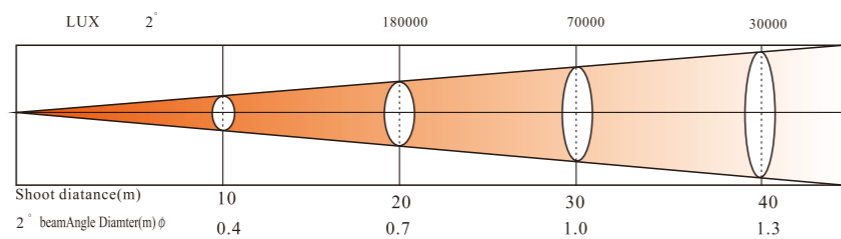

Beam Moving Head Lights

SR-400

光束/图案摇头灯



◎ 技术参数:

灯泡: Philips 17R 20R  
 功耗: 230V 50HZ 500-600VA  
 光学器件: 高效率镜头组, 变焦2.5°-30°  
 电子聚焦: 10米处, 160000LUX  
 通道模式: 20/24个国际标准DMX512通道  
 水平扫描: 540° (16bit精度扫描)  
 垂直扫描: 270° (16bit精度扫描)  
 色片盘: 13个色片+白光,  
 带双向旋转的彩虹效果  
 旋转图案盘: 7个图案片+白圆,  
 带图案抖动和图案任意定位功能  
 效果图案盘: 2个, 12图案和8图案  
 棱镜盘: 2个可旋转棱镜, 一个圆形32棱镜,  
 一个碎花棱镜, 可叠加。可正反方向  
 旋转, 并具有棱镜定位功能。  
 频闪: 双铡刀频闪频率最高可以0.5-9次每秒,  
 并可选择随机频闪及脉冲频闪  
 调光: 0%~100%线性调光  
 雾化: 0%~100%线性雾化  
 电子整流器: 使产品重量更轻, 亮度更强,  
 灯泡更稳定, 更环保, 更节能  
 开关电源: AC100~240V, 50/60HZ  
 灯体尺寸: 长400×宽320×高650 (mm)  
 包装尺寸: 长470×宽450×高680 (mm)  
 净重: 21公斤  
 毛重: 24公斤

◎ TECHNICAL PARAMETER:

BULB: Philips 17R 20R  
 POWER CONSUMPTION: 230V 50HZ 500-600VA  
 OPTICAL DEVICE: high efficiency lens group, 2.5°-30°  
 ELECTRONIC FOCUS: 10 meters, 160000 LUX  
 CHANNEL MODE: 20/24 international standard  
 DMX512 channel  
 LEVEL SCANNING: 540°(16 bit precision scan)  
 VERTICAL SCAN: 270°(16 bit precision scan)  
 COLOR WHEEL: 13 dichroic filters + white light,  
 with two-way rotating and rainbow effect  
 ROTATING GOBO WHEEL: 7 gobos and white circle  
 with design jitter and arbitrary positioning  
 function  
 Effect GOBO WHEEL: two wheel 12gobo, 8gobo  
 PRISM: 2 prism, (1) a 32-facet circular prism ,  
 (2) a floral prism, with superposition, positive  
 and negative rotation and prism location  
 function.  
 SHUT: Double pole shut up to 0.5-9 times per second,  
 random shut and pulse shut can be choosed  
 DIMMER: 0% ~ 100% linear dimmer  
 Electronic ballast : make the product more light and  
 bright. Lamp more stable environmental  
 protection and more energy saving  
 SWITCHING POWER SUPPLY : AC100 ~ 240 V,  
 50/60 HZ  
 FIXTURE DIMENSION: L400×W320×H650(mm)  
 PACKING DIMENSION: L470×W450×H680(mm)  
 NET WEIGHT: 21KG  
 GROSS WEIGHT: 24KG

SR-400 DMX Standard Channel Control

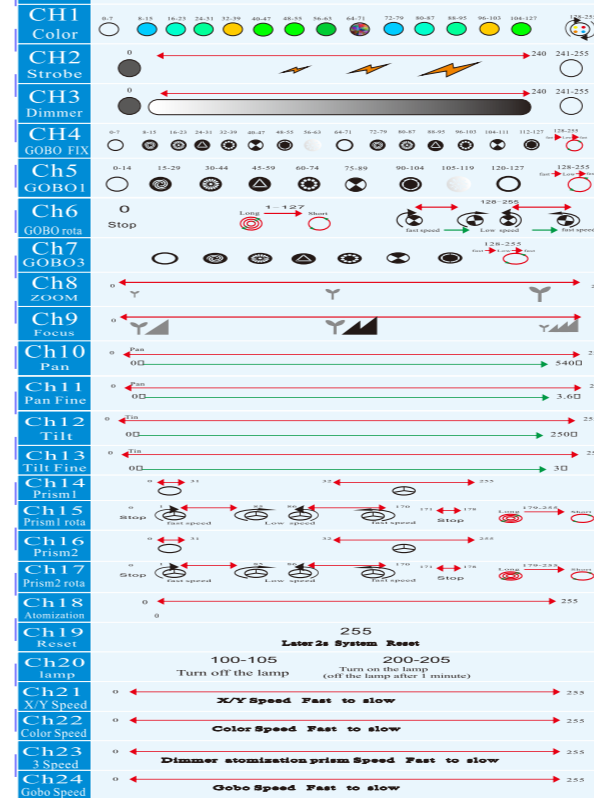

SR-400 >>光效图

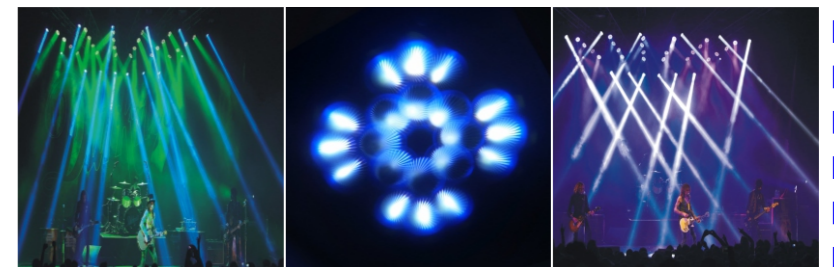
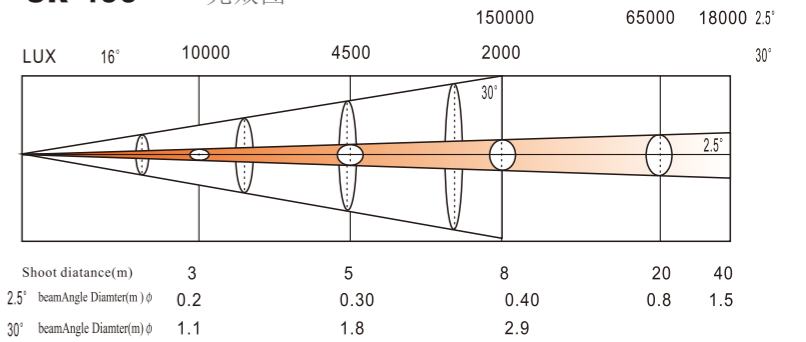

Beam Moving Head Lights  
**SR-330B**

光束/图案摇头灯



SR-330B DMX Standard Channel Control	
CH1 Color	0-7, 8-15, 16-23, 24-31, 32-39, 40-47, 48-55, 56-63, 64-71, 72-79, 80-87, 88-95, 96-103, 104-127, 128-255
CH2 Strobe	0, 240, 241-255
CH3 Dimmer	0, 240, 241-255
CH4 GOBO FIX	0-7, 8-15, 16-23, 24-31, 32-39, 40-47, 48-55, 56-63, 64-71, 72-79, 80-87, 88-95, 96-103, 104-127, 128-255
Ch5 GOBO	0-14, 15-29, 30-44, 45-59, 60-74, 75-89, 90-104, 105-119, 120-137, 128-255
Ch6 GOBO rota	0, 128-255
Ch7 Prism1	0, 31, 32, 255
Ch8 Prism1 rota	0, 170, 171, 178, 179-255
Ch9 Prism2	0, 31, 32, 255
Ch10 Prism2 rota	0, 170, 171, 178, 179-255
Ch11 ZOOM	0, 255
Ch12 Focus	0, 255
Ch13 Pan	0, 540D, 255
Ch14 Pan Fine	0, 3.6D, 255
Ch15 Tilt	0, 250D, 255
Ch16 Tilt Fine	0, 3D, 255
Ch17 X/Y Speed	0, 255
Ch18 Reset	100-105, 200-205, 255

◎ TECHNICAL PARAMETER:

Voltage : 110V~240V/50-60Hz  
Ballast: Electronic Ballast  
Lamp : Philips 15 R 300WJSR-330BJ  
OSRAM 10R 280W JSR-280J  
Power consumption: 500WJSR-330BJ,470WJSR-280J  
Lens : high precision optical lens  
Color wheel: 13 dichroic filters + whiteRotating  
Gobo Wheel: with 9 bi directional and indexable gobos  
(outside diameter: 12,4 mm, image diameter: 10 mm)JSR-330BJ  
(outside diameter: 15,4 mm, image diameter: 13 mm)JSR-280J  
Static Gobo wheel with 14 fixed gobos,  
at variable rotation  
Prism : Prism 1 16-facet circular prism , Prism 2 6-facet linear prismJ  
with superposition(SR-330B).  
Prism 1 8-facet circular prism , Prism 2 6-facet linear prismJ  
(SR-280).  
Prism rotating in both directions at different speeds.  
Zoom: parallel beam angel 2.5Y-30Y(SR-330B) 2.5Y-20Y(SR-280) change  
Wash effect : adjustable Wash effects angle(only sr-280)  
Focus: linear adjustment  
Dimmer : 0-100% linear adjustment  
Strobe : Double lens strobe (0.5-9 times/ second)  
Pan/Tilt : X axis 540Y Y axis 270Yautomatically accurate  
positioning  
Fixation option: Pan/Tilt-lock mechanism  
Control mode : Standard DMX512, Automatic and Master/ slave mode  
Channel : 18 CHs / 22 Chs (SR-330B), 16 CHs / 24 Chs(SR-280)  
Controller can open the lamp and reset, including delaying function  
NET Weight : 18KG Gross Weight: 21KG  
Dimension: 365 (L) X 285 (W) X 590 (H) mm  
Packing dimension: 470 (L) X 370 (W) X 680 (H) mm

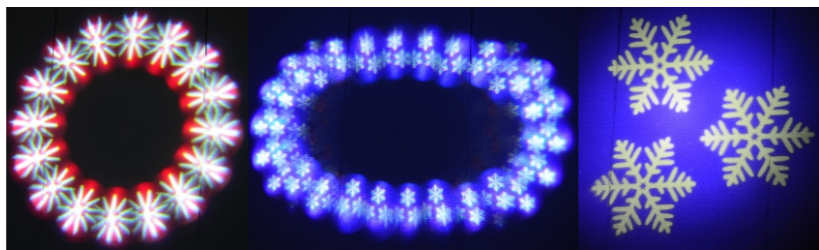

◎ 技术参数:

通道数: 18/22 两种通道选择模式 (SR-330B) ,  
16/24 两种通道选择模式 (SR-280) 。  
灯泡型号: Philips 15 R 功率: 300W (SR-330B)  
OSRAM 10R 功率: 280W (SR-280)  
显示: 2.2寸彩屏触摸液晶显示屏,可倒转180° 显示。  
颜色盘:一个颜色盘,有13个色片。  
图案盘:两个图案盘,固定图案盘13个图案+白光, 旋转图案盘9个图案+白光。  
旋转图案片直径: 12.4mm, 有效内直径:10mm (SR-330B) 。  
15.4mm, 有效内直径:13mm (SR-280) 。  
效果轮: 两个可旋转棱镜,一个圆形16棱镜, 一个直线六棱镜, 可叠加 (SR-330B) 。  
两个可旋转棱镜,一个圆形8棱镜, 一个直线六棱镜, 雾化功能 (SR-280) 。  
0-100%机械调光, 支持机械频闪和可调变频闪效果, 支持频闪宏功能。  
镜头组光学系统,电动对焦, 光束角2.5~30° (SR-330B) 2.5~20° (SR-280) 。  
采用光电复位系统, 当偶然发生误动后, 可自动检索复位。  
水平540°, 解析度8Bit/16Bit。  
垂直270°, 解析度8Bit/16Bit。  
过热保护。  
电源: 100-240V, 50/60Hz  
功率: 500W (SR-330B) , 470W (SR-280)  
IP防护等级: IP20  
电子整流器。  
灯具尺寸: 365 (长) × 285 (宽) × 590 (高) mm  
包装尺寸: 470 (长) × 370 (宽) × 680 (高) mm  
净重: 18KG 毛重: 21公斤

SR-330B >>光效图

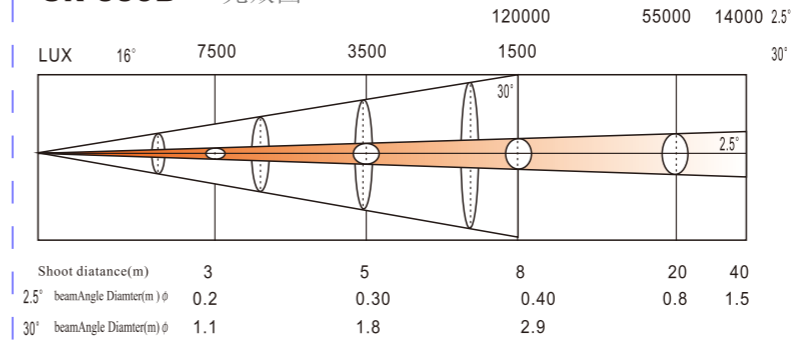

SR-280 >>光效图

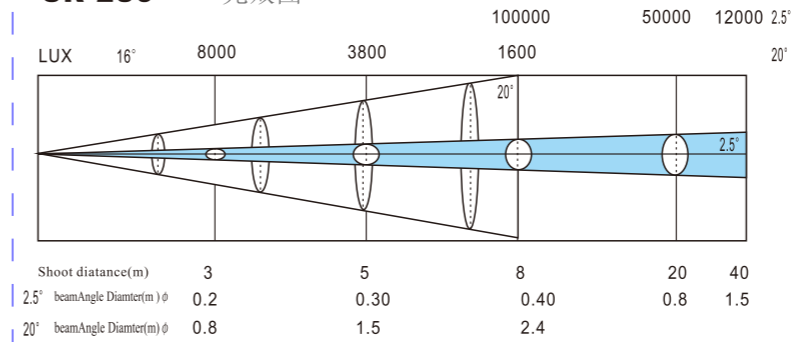

Beam Moving Head Lights  
**SR-280**

光束/图案摇头灯



DMX CHART			
CH24	CH16	FUNCTION	DESCRIPTION
CH1	CH1	PAN	540°
CH2		PAN FINE	1.8°
CH3	CH2	TILT	270°
CH4		TILT FINE	1.8°
CH5	CH3	X/Y SPEED	000-255
CH6	CH4	MACRO	000-255
CH7	CH5	COLOR	000-255
CH8			000-255
CH9	CH6		000-255
CH10	CH7	GOBO 1	000-255
CH11	CH8	GOBO 2	000-255
CH12	CH9	GOBO ROTATION	000-255
CH13			000-255
CH14	CH10	PRISMA	000-255
CH15	CH11	ROTPRISM	000-255
CH16	CH12	FROST	000-255
CH17	CH13	ZOOM	000-255
CH18		ZOOM FINE	000-255
CH19	CH14	FOCUS	000-255
CH20		ZOOM FOCUS	000-255
CH21			000-255
CH22	CH15	SHUTTER	000-255
CH23	CH16	DIMMER	000-255
CH24			000-255

## SR-260



### ◎ 技术参数:

灯泡: OSRAM 9R  
 功耗: 230V 50HZ 400VA  
 光学器件: 高效率镜头组, 变焦0°至1.5°  
 电子聚焦: 20米处, 130000LUX  
 通道模式: 16个两种国际标准DMX512通道  
 水平扫描: 540° (16bit精度扫描)  
 垂直扫描: 280° (16bit精度扫描)  
 色片盘: 13个色片+白光, 带双向旋转的彩虹效果  
 旋转图案盘: 13个图案片+白圆, 带图案抖动和图案任意定位功能  
 棱镜盘: 5个可旋转棱镜, 两个棱镜盘可叠加。可正反方向旋转。  
 频闪: 双铡刀频闪频率最高可以13次每秒, 并可选择随机频闪及脉冲频闪  
 调光: 0%~100%线性调光  
 雾化: 0%~100%线性雾化  
 电子整流器: 使产品重量更轻, 亮度更强, 灯泡更稳定, 更环保, 更节能  
 开关电源: AC100~240V, 50/60HZ  
 灯体尺寸: 长310×宽250×高520 (mm)  
 包装尺寸: 长405×宽320×高615 (mm)  
 净重: 14公斤  
 毛重: 16公斤

### ◎ TECHNICAL PARAMETER:

BULB: OSRAM 9R  
 POWER CONSUMPTION: 230 V 50 HZ 400 VA  
 OPTICAL DEVICE: high efficiency lens group, 0° -1.5° zoom  
 ELECTRONIC FOCUS: 20 meters, 130000 LUX  
 CHANNEL MODE: 16 standard DMX512 channel  
 LEVEL SCANNING: 540(16 bit precision scan)  
 VERTICAL SCAN: 280(16 bit precision scan)  
 COLOR WHEEL: 13color and white light with two-way rotating and rainbow effect  
 ROTATING GOBO WHEEL: 13 gobos and white circle with design jitter and arbitrary positioning function  
 PRISM: 5 prism, 2 prism wheel with superposition, positive and negative rotation .  
 SHUT: Double pole shut up to 13 times per second, random shut and pulse shut can be choosed  
 DIMMER: 0% ~ 100% linear dimmer  
 FROST: 0% ~ 100% linear frost  
 Electronic ballast : make the product more light and bright, Lamp more stable environmental protection and more energy saving  
 SWITCHING POWER SUPPLY : AC100 ~ 240 V, 50/60 HZ  
 FIXTURE DIMENSION: L310×250×520(mm)  
 PACKING DIMENSION: L405×320×615(mm)  
 NET WEIGHT: 14KG  
 GROSS WEIGHT: 16KG

### SR-260 >>光效图

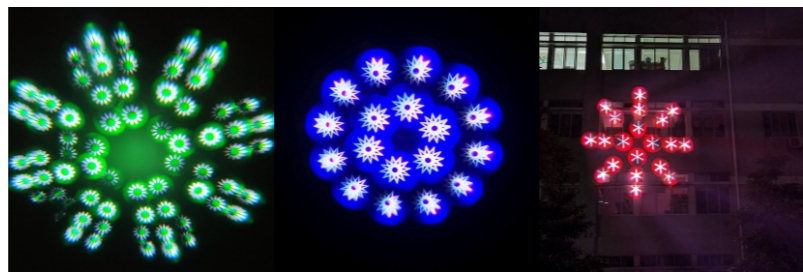
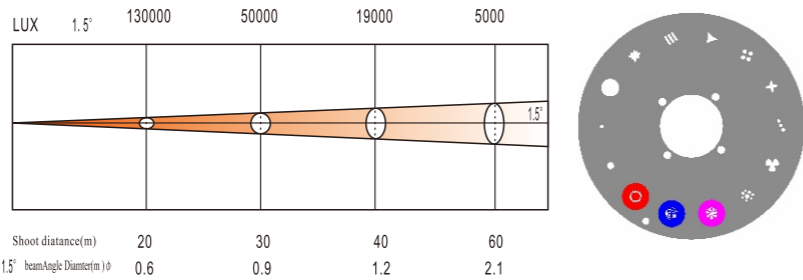

SR-260 DMX Channel Control	
Ch1 Pan	0° to 540°
Ch2 Tilt	0° to 250°
Ch3 Pan Fine	0° to 3.6°
Ch4 Tilt Fine	0° to 3°
Ch5 X/Y Speed	Fast to slow
Ch6 Color	0 to 255
Ch7 Strobe	0 to 240-255
Ch8 Dimmer	0 to 240-255
Ch9 Color	0-7, 8-15, 16-23, 24-31, 32-39, 40-47, 48-55, 56-63, 64-71, 72-79, 80-87, 88-95, 96-103, 104-111, 112-119, 120-127, 128-135, 136-143, 144-151, 152-159, 160-167, 168-175, 176-183, 184-191, 192-199, 200-207, 208-215, 216-223, 224-231, 232-239, 240-247, 248-255
Ch10 GOBO	0 to 255
Ch11 Prism1	0 to 255
Ch12 Prism1 rotate	0 to 360度定位
Ch13 Prism2	0 to 255
Ch14 Prism2 rotate	0 to 360度定位
Ch15 Focus	0 to 255
Ch16 Reset	100-105 Turn off the lamp, 200-205 Turn on the lamp (off the lamp after 1 minute), 255 Later 2s System Reset

### ◎ 技术参数:

灯泡: Philips 15R  
 功耗: 230V 50HZ 450VA  
 光学器件: 高效率镜头组, 变焦1.5°  
 电子聚焦: 20米处, 160000LUX  
 通道模式: 16个国际标准DMX512通道  
 水平扫描: 540° (16bit精度扫描)  
 垂直扫描: 270° (16bit精度扫描)  
 色片盘: 13个色片+白光, 带双向旋转的彩虹效果  
 图案盘: 13个图案片+白圆, 带图案抖动和图案任意定位功能  
 棱镜盘: 两个可旋转棱镜, 一个圆形32棱镜, 一个碎花棱镜, 可叠加。可正反方向旋转, 并具有棱镜定位功能。  
 频闪: 双铡刀频闪频率最高可以0.5-9次每秒, 并可选择随机频闪及脉冲频闪  
 调光: 0%~100%线性调光  
 雾化: 0%~100%线性雾化  
 电子整流器: 使产品重量更轻, 亮度更强, 灯泡更稳定, 更环保, 更节能  
 开关电源: AC100~240V, 50/60HZ  
 灯体尺寸: 长365×宽285×高590 (mm)  
 包装尺寸: 长470×宽370×高680 (mm)  
 净重: 18公斤  
 毛重: 21公斤

### ◎ TECHNICAL PARAMETER:

BULB: Philips 15R  
 POWER CONSUMPTION: 230V 50HZ 450VA  
 OPTICAL DEVICE: high efficiency lens group, 1.5° zoom  
 ELECTRONIC FOCUS: 20 meters, 160000 LUX  
 CHANNEL MODE: 16 international standard DMX512 channel  
 LEVEL SCANNING: 540° (16 bit precision scan)  
 VERTICAL SCAN: 270° (16 bit precision scan)  
 COLOR WHEEL: 13 dichroic filters + white light, with two-way rotating and rainbow effect  
 ROTATING GOBO WHEEL: 13 gobos and white circle with design jitter and arbitrary positioning function  
 PRISM: two prism, (1) a 32-facet circular prism, (2) a floral prism, with superposition, positive and negative rotation and prism location function.  
 SHUT: Double pole shut up to 0.5-9 times per second, random shut and pulse shut can be choosed  
 DIMMER: 0% ~ 100% linear dimmer  
 Electronic ballast : make the product more light and bright. Lamp more stable environmental protection and more energy saving  
 SWITCHING POWER SUPPLY : AC100 ~ 240 V, 50/60 HZ  
 FIXTURE DIMENSION: L365×W285×H590(mm)  
 PACKING DIMENSION: L470×W370×H680(mm)  
 NET WEIGHT: 18KG  
 GROSS WEIGHT: 21KG

### SR-330PLUS >>光效图

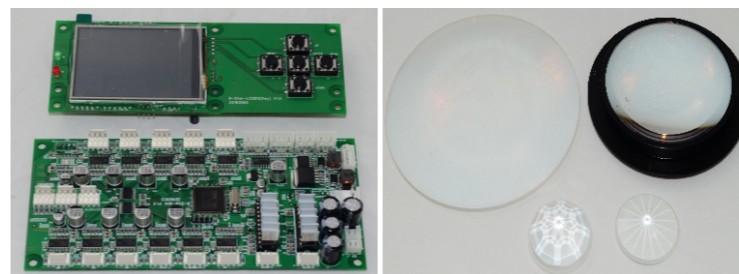
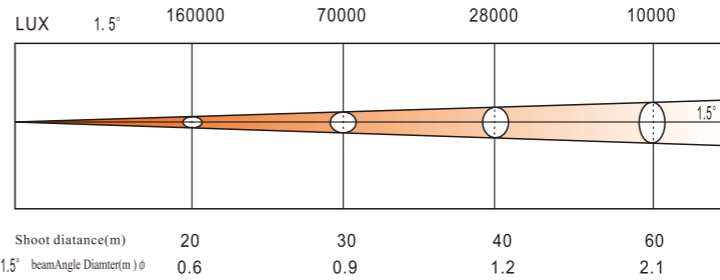

## SR-330PLUS



SR-330 PLUS DMX Channel Control	
Ch1 Pan	0° to 540°
Ch2 Tilt	0° to 250°
Ch3 Pan Fine	0° to 3.6°
Ch4 Tilt Fine	0° to 3°
Ch5 X/Y Speed	Fast to slow
Ch6 Atomization	0 to 255
Ch7 Strobe	0 to 240-255
Ch8 Dimmer	0 to 240-255
Ch9 Color	0-7, 8-15, 16-23, 24-31, 32-39, 40-47, 48-55, 56-63, 64-71, 72-79, 80-87, 88-95, 96-103, 104-111, 112-119, 120-127, 128-135, 136-143, 144-151, 152-159, 160-167, 168-175, 176-183, 184-191, 192-199, 200-207, 208-215, 216-223, 224-231, 232-239, 240-247, 248-255
Ch10 Color	0 to 255
Ch11 GOBO	0 to 255
Ch12 GOBO shake	0 to 255
Ch13 Focus	0 to 255
Ch14 Prism1	0 to 255
Ch15 Prism2	0 to 255
Ch16 Reset	100-105 Turn off the lamp, 200-205 Turn on the lamp (off the lamp after 1 minute), 255 Later 2s System Reset

**SR-230PLUS/PRO**



◎ 技术参数:

灯泡: OSRAM 7R  
(8000K色温, 2000小时)  
功耗: 230V 50HZ 380VA  
光学器件: 3片透镜式镜头组, 变焦0°至3°  
显示: 2.2寸触摸液晶显示屏  
电子聚焦: 20米处, 65000LUX  
通道模式: 16 (18 SR-230PRO) 个  
国际标准DMX512通道  
水平扫描: 540° (16bit精度扫描)  
垂直扫描: 280° (16bit精度扫描)  
色片盘: 14个色片+白光,  
带双向旋转的彩虹效果  
旋转图案盘: 7个图案片+白圆,  
图案自转和图案任意定位功能  
图案盘: 17个图案片+白圆,  
带图案抖动和图案任意定位功能  
棱镜盘: 48棱镜和排镜, 都可正反  
方向旋转, 并具有棱镜定位功能。  
频闪: 双铡刀频闪频率最高可以13次每秒,  
并可选择随机频闪及脉冲频闪  
调光: 0%~100%线性调光  
雾化: 七色盘效果  
电子整流器: 使产品重量更轻, 亮度更强,  
灯泡更稳定, 更环保, 更节能  
开关电源: AC100~240V, 50/60HZ  
灯体尺寸: 长430×宽330×高510 (mm)  
包装尺寸: 长460×宽385×高565 (mm)  
净重: 16.5公斤  
毛重: 19公斤

◎ TECHNICAL PARAMETER:

BULB: OSRAM 7R  
(8000 K color temperature, 2000 hours)  
POWER CONSUMPTION: 230 V 50 HZ 380-430 VA  
OPTICAL DEVICE: three lens group, 0° -3° zoom  
ELECTRONIC FOCUS: 20 meters 65000LUX  
CHANNEL MODE: 16 (18 SR-230PRO) international  
standard DMX512 channel  
LEVEL SCANNING: 540 (16 bit precision scan)  
VERTICAL SCAN: 280 (16 bit precision scan)  
COLOR WHEEL: 14color and white light with  
wo-way rotating and rainbow effect  
ROTATING GOBO WHEEL: 7 gobos and white circle  
gobo rotating andarbitrary positioning function  
GOBO WHEEL: 17 gobos and white circle  
with design jitter andarbitrary positioning function  
PRISM: 48 prisms , 6 facet linear prism with positive and  
negative rotation and prism location function.  
SHUT: Double pole shut up to 13 times per second,  
random shut and pulse shut can be choosed  
DIMMER: 0% ~ 100% linear dimmer  
FROST: 7 Color wheel  
Electronic ballast : make the product more light and bright.  
Lamp more stable environmental protection and  
more energy saving  
SWITCHING POWER SUPPLY : AC100 ~ 240 V. 50/60 HZ  
FIXTURE DIMENSION: L430×330×510 (mm)  
PACKING DIMENSION: L460×385×565 (mm)  
NET WEIGHT: 16.5KG  
GROSS WEIGHT: 19KG

**15R Mini Beam Moving Head Lights-high speed**

◎ 技术参数:

灯泡: Philips 15R (SR-300)  
OSRAM 7R (SR-230)  
(8000K色温, 2000小时)  
功耗: 230V 50HZ 380-450VA  
光学器件: 3片透镜式镜头组, 变焦0°至3°  
电子聚焦: 20米处, 80000LUX (SR-330)  
65000LUX (SR-230)  
通道模式: 16个国际标准DMX512通道  
水平扫描: 540° (16bit精度扫描)  
垂直扫描: 280° (16bit精度扫描)  
色片盘: 14个色片+白光,  
带双向旋转的彩虹效果  
图案盘: 17个图案片+白圆,  
带图案抖动和图案任意定位功能  
棱镜盘: 8棱镜 (SR-330 5/8棱镜), 可正反  
方向旋转, 并具有棱镜定位功能。  
频闪: 双铡刀频闪频率最高可以13次每秒,  
并可选择随机频闪及脉冲频闪  
调光: 0%~100%线性调光  
雾化: 七色盘效果  
电子整流器: 使产品重量更轻, 亮度更强,  
灯泡更稳定, 更环保, 更节能  
开关电源: AC100~240V, 50/60HZ  
灯体尺寸: 长430×宽330×高510 (mm)  
包装尺寸: 长460×宽385×高565 (mm)  
净重: 16.5公斤  
毛重: 19公斤

◎ TECHNICAL PARAMETER:

BULB: Philips 15 R (SR-230).  
OSRAM 7R (SR-230)  
(8000 K color temperature, 2000 hours)  
POWER CONSUMPTION: 230 V 50 HZ 380-430 VA  
OPTICAL DEVICE: three lens group, 0° -3° zoom  
ELECTRONIC FOCUS: 20 meters, 80000 LUX (SR-330),  
65000 LUX (SR-230)  
CHANNEL MODE: 16 international standard  
DMX512 channel  
LEVEL SCANNING: 540 (16 bit precision scan)  
VERTICAL SCAN: 280 (16 bit precision scan)  
COLOR WHEEL: 14color and white light with  
wo-way rotating and rainbow effect  
GOBO WHEEL: 17 gobos and white circle  
with design jitter andarbitrary positioning function  
PRISM: 8 prisms (SR-330 5/8prisms) with positive and  
negative rotation and prism location function.  
SHUT: Double pole shut up to 13 times per second,  
random shut and pulse shut can be choosed  
DIMMER: 0% ~ 100% linear dimmer  
FROST: 0% ~ 100% linear frost  
Electronic ballast : make the product more light and bright.  
Lamp more stable environmental protection and  
more energy saving  
SWITCHING POWER SUPPLY : AC100 ~ 240 V. 50/60 HZ  
FIXTURE DIMENSION: L430×330×510 (mm)  
PACKING DIMENSION: L460×385×565 (mm)  
NET WEIGHT: 16.5KG  
GROSS WEIGHT: 19KG

**15R 迷你版光束摇头灯-高速度**

**SR-330/230**



SR-230Plus DMX Channel Control	
CH1 Pan	0° ~ 540°
CH2 Tilt	0° ~ 250°
CH3 Pan Fine	0° ~ 3.6°
CH4 Tilt Fine	0° ~ 3°
Ch5 X/Y Speed	X/Y Speed Fast to slow
Ch6 7 COLOR	0 ~ 255
Ch7 Strobe	0 ~ 240 241-255
Ch8 Dimmer	0 ~ 240 241-255
Ch9 Color	0-7 8-15 16-23 24-31 32-39 40-47 48-55 56-63 64-71 72-79
Ch10 Color	颜色渐变 颜色渐变
Ch11 GOBO	0-6 7-13 14-20 21-27 28-34 35-41 42-48 49-55 56-62 63-69
Ch12 GOBO shake	0 ~ 1 192 ~ 255
Ch13 Focus	0 ~ 1 192 ~ 255
Ch14 Prism1	0 ~ 31 32 ~ 127 128 ~ 191 192 ~ 255
Ch15 Prism2	0 ~ 31 32 ~ 127 128 ~ 191 192 ~ 255
Ch16 Reset	100-105 Turn off the lamp 200-205 Turn on the lamp (off the lamp after 1 minute) 255 Later 2s System Reset

SR-230PRO DMX Channel Control	
CH1 Pan	0° ~ 540°
CH2 Tilt	0° ~ 250°
CH3 Pan Fine	0° ~ 3.6°
CH4 Tilt Fine	0° ~ 3°
Ch5 X/Y Speed	X/Y Speed Fast to slow
Ch6 7 COLOR	0 ~ 255
Ch7 Strobe	0 ~ 240 241-255
Ch8 Dimmer	0 ~ 240 241-255
Ch9 Color	0-7 8-15 16-23 24-31 32-39 40-47 48-55 56-63 64-71 72-79
Ch10 Color	颜色渐变 颜色渐变
Ch11 GOBO	0-6 7-13 14-20 21-27 28-34 35-41 42-48 49-55 56-62 63-69
Ch12 GOBO shake	0 ~ 1 192 ~ 255
Ch13 Focus	0 ~ 1 192 ~ 255
Ch14 Prism1	0 ~ 31 32 ~ 127 128 ~ 191 192 ~ 255
Ch15 Prism2	0 ~ 31 32 ~ 127 128 ~ 191 192 ~ 255
Ch16 Reset	100-105 Turn off the lamp 200-205 Turn on the lamp (off the lamp after 1 minute) 255 Later 2s System Reset



>>光效图

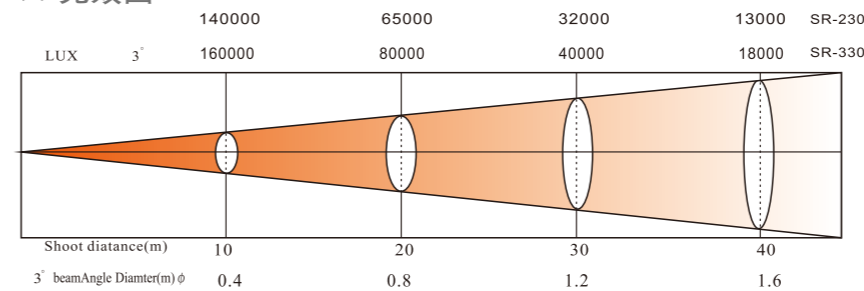

SR-330/230 DMX Channel Control	
CH1 Pan	0° ~ 540°
CH2 Tilt	0° ~ 250°
CH3 Pan Fine	0° ~ 3.6°
CH4 Tilt Fine	0° ~ 3°
Ch5 X/Y Speed	X/Y Speed Fast to slow
Ch6 SR-330 PRISM SR-230 ATOMIZATION	0 ~ 255
Ch7 Strobe	0 ~ 240 241-255
Ch8 Dimmer	0 ~ 240 241-255
Ch9 Color	0-7 8-15 16-23 24-31 32-39 40-47 48-55 56-63 64-71 72-79
Ch10 Color	颜色渐变 颜色渐变
Ch11 GOBO	0-6 7-13 14-20 21-27 28-34 35-41 42-48 49-55 56-62 63-69
Ch12 GOBO shake	0 ~ 1 192 ~ 255
Ch13 Focus	0 ~ 1 192 ~ 255
Ch14 Prism	0 ~ 31 32 ~ 127 128 ~ 191 192 ~ 255
Ch15 Prism rota	0 ~ 31 32 ~ 127 128 ~ 191 192 ~ 255
Ch16 Reset	100-105 Turn off the lamp 200-205 Turn on the lamp (off the lamp after 1 minute) 255 Later 2s System Reset

## SR-230B



### ◎ 技术参数:

灯 泡: OSRAM 7R  
(8000K色温, 2000小时)  
功 耗: 230V 50HZ 380VA  
光学器件: 3片透镜式镜头组, 变焦0°至3°  
显示: 2.2寸触摸液晶显示屏  
电子聚焦: 20米处, 65000LUX  
通道模式: 16个国际标准DMX512通道  
水平扫描: 540° (16bit精度扫描)  
垂直扫描: 280° (16bit精度扫描)  
色 片 盘: 14个色片+白光,  
带双向旋转的彩虹效果  
图案盘: 17个图案片+白圆,  
带图案抖动和图案任意定位功能  
棱 镜 盘: 16棱镜和排镜, 都可正反  
方向旋转, 并具有棱镜定位功能。  
频 闪: 双铡刀频闪频率最高可以13次每秒,  
并可选择随机频闪及脉冲频闪  
调 光: 0%~100%线性调光  
雾 化: 0%~100%线性雾化  
电子整流器: 使产品重量更轻, 亮度更强,  
灯泡更稳定, 更环保, 更节能  
开关电源: AC100~240V, 50/60HZ  
灯体尺寸: 长430×宽330×高510(mm)  
包装尺寸: 长460×宽385×高565(mm)  
净 重: 16.5公斤  
毛 重: 19公斤

### ◎ TECHNICAL PARAMETER:

BULB: OSRAM 7R  
(8000 K color temperature, 2000 hours)  
POWER CONSUMPTION: 230 V 50 HZ 380-430 VA  
OPTICAL DEVICE: three lens group, 0°-3° zoom  
ELECTRONIC FOCUS: 20 meters.  
CHANNEL MODE: 16 international standard  
DMX512 channel  
LEVEL SCANNING: 540 (16 bit precision scan)  
VERTICAL SCAN: 280 (16 bit precision scan)  
COLOR WHEEL: 14 color and white light with  
wo-way rotating and rainbow effect  
GOBO WHEEL: 17 gobos and white circle  
with design jitter and arbitrary positioning function  
PRISM: 16 prisms, 6 facet linear prism with positive and  
negative rotation and prism location function.  
SHUT: Double pole shut up to 13 times per second,  
random shut and pulse shut can be choosed  
DIMMER: 0% ~ 100% linear dimmer  
FROST: 0% ~ 100% linear frost  
Electronic ballast: make the product more light and bright.  
Lamp more stable environmental protection and  
more energy saving  
SWITCHING POWER SUPPLY: AC100 ~ 240 V, 50/60 HZ  
FIXTURE DIMENSION: L430×330×510(mm)  
PACKING DIMENSION: L460×385×565(mm)  
NET WEIGHT: 16.5KG  
GROSS WEIGHT: 19KG

### ◎ 技术参数:

灯 泡: M S D 2R (7000K色温,  
2000小时)  
功 耗: 230V 50HZ 200VA  
光学器件: 3片透镜式镜头组, 变焦0°至3°  
电子聚焦: 20米处, 40000LUX  
通道模式: 16个国际标准DMX512通道  
水平扫描: 540° (16bit精度扫描)  
垂直扫描: 280° (16bit精度扫描)  
色 片 盘: 12个色片+白光,  
带双向旋转的彩虹效果  
旋转图案盘: 15个图案片+白圆,  
带图案抖动和图案任意定位功能  
棱 镜 盘: 8棱镜, 可正反方向旋转,  
并具有棱镜定位功能  
频 闪: 双铡刀频闪频率最高可以13次  
每秒, 并可选择随机频闪及脉冲频闪  
调 光: 0%~100%线性调光  
雾 化: 0%~100%线性雾化  
电子整流器: 使产品重量更轻, 亮度更强,  
灯泡更稳定, 更环保, 更节能  
开关电源: AC100~240V, 50/60HZ  
灯体尺寸: 长365×宽250×高420(mm)  
包装尺寸: 长415×宽345×高440(mm)  
净 重: 10.5公斤  
毛 重: 11.5公斤

### ◎ TECHNICAL PARAMETER:

BULB: YODU 2 R (7000 K color temperature, 2000 hours)  
POWER CONSUMPTION: 230 V 50 HZ 200 VA  
OPTICAL DEVICE: three lens group, 0-3° zoom  
ELECTRONIC FOCUS: 20 meters, 40000 LUX  
CHANNEL MODE: 16 international standard DMX512 channel  
LEVEL SCANNING: 540 (16 bit precision scan)  
VERTICAL SCAN: 280 (16 bit precision scan)  
COLOR WHEEL: 12 color and white light with two-way  
rotating and rainbow effect  
ROTATING GOBO WHEEL: 15 gobos and white circle with  
design jitter and arbitrary positioning function  
PRISM: 8 prisms with positive and negative rotation  
and prism location function.  
SHUT: Double pole shut up to 13 times per second,  
random shut and pulse shut can be choosed  
DIMMER: 0% ~ 100% linear dimmer  
FROST: 0% ~ 100% linear frost  
Electronic ballast: make the product more light and bright.  
Lamp more stable environmental protection  
and more energy saving  
SWITCHING POWER SUPPLY: AC100 ~ 240 V, 50/60 HZ  
FIXTURE DIMENSION: L365×250×420(mm)  
PACKING DIMENSION: L415×345×440(mm)  
NET WEIGHT: 10.5KG  
GROSS WEIGHT: 11.5KG

## SR-130



### >>光效图

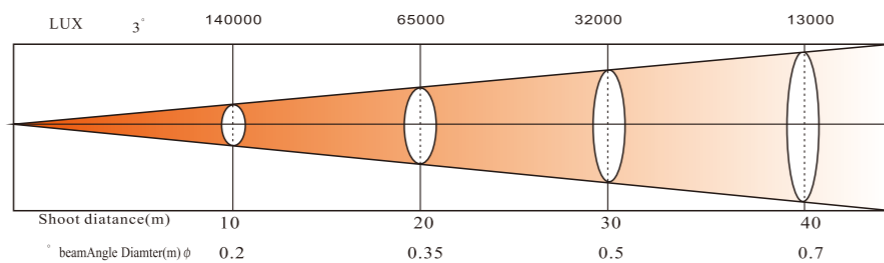

### >>光效图

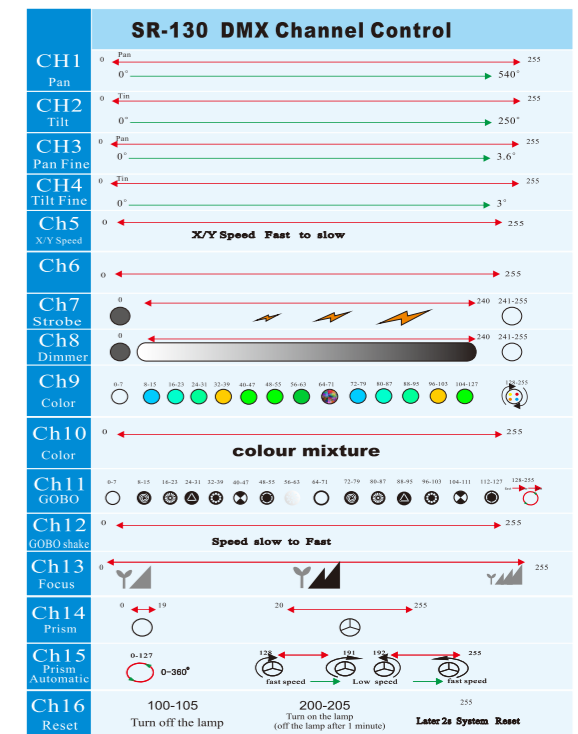
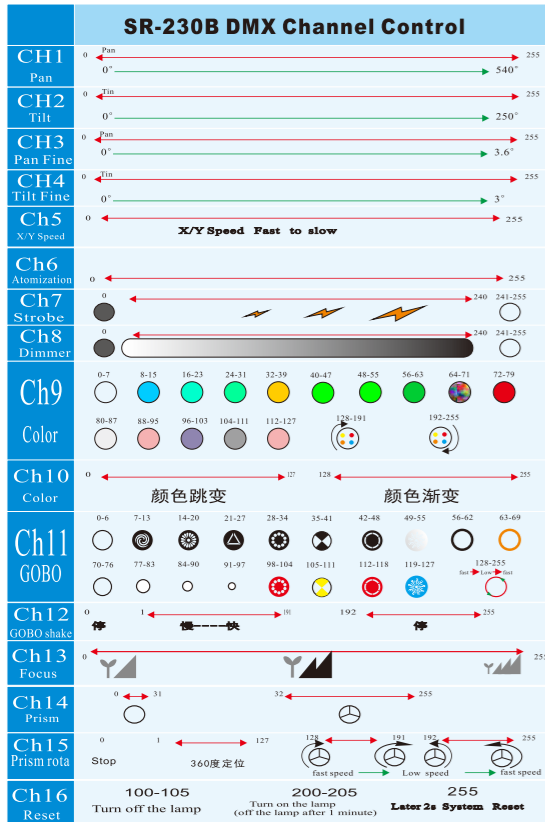
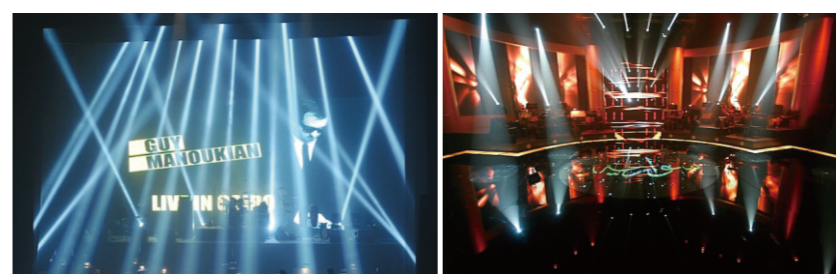
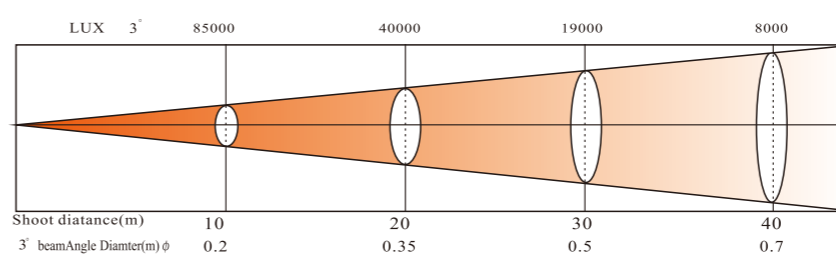

## THUNDER-200 LED 三合一摇头灯



### ◎ 技术参数:

额定电压: AC90-240V, 50/60Hz  
光源: 200瓦 LED 白光  
额定功率: 300w  
使用寿命: 50,000小时  
净重: 14公斤  
毛重: 16公斤  
灯体尺寸: 长310×宽250×高520 (mm)  
包装尺寸: 长405×宽320×高615 (mm)

### ◎ 性能特点:

光斑角度(可变焦): 8°—30°  
颜色轮: 9个颜色片+白光, 半色效果, 可做双向变速彩虹效果。  
图案: 旋转图案轮: 7个可更换图案片(其中2个玻璃图案)+白光, 可做双向变速效果。  
图案: 固定图案轮: 9个可更换图案片+白光, 可做双向变速效果。  
棱镜: 三棱镜, 双向旋转, 速度可调  
调焦: 线性调焦  
雾化: 0%-100%可调  
调光: 0-100%线性调光  
频闪: 0.5-20次/秒, 速度可调  
旋转角度: 水平540°, 垂直270° (自动回位纠错功能, 具有16bit精度调节)  
控制: 具有颜色+图案+棱镜+水平/垂直切光功能  
制: 国际标准DMX512信号, 3芯接口  
通道: 16CH/20CH  
显示: 触摸显示屏, 显示可选倒置  
防护等级: IP20, 内置过热和触发高压保护, LED 温度显示

### ◎ TECHNICAL PARAMETER:

VOLTAGE: AC90- 240V 50/60Hz  
LIGHT SOURCE: 200W LED  
POWER CONSUMPTION: 300W  
NET WEIGHT: 14KG  
GROSS WEIGHT: 16KG  
FIXTURE DIMENSION: L310×W250×H520(mm)  
PACKING DIMENSION: L405×W320×H615(mm)

### ◎ PERFORMANCE FEATURE:

BEAM ANGLE: 8°—30°  
1 COLOR WHEEL: 9 colors+open, half color effect, bi-directional rainbow effect at variable speed  
1 ROTATING GOBO WHEEL: 7 rotating gobos+open, bi-directionally rotating at variable speed  
1 FIX GOBO WHEEL: 9 fix gobos+open, bi-directionally rotating at variable speed  
1 PRISM WHEEL: 3-facet prism, bi-directionally rotating, at variable speed  
FOCUS: Linearly adjustable  
WASH: 0-100% adjustable  
DIMMER: 0-100% linearly adjustable  
STROBE: 0.5-20 flash per second, speed adjustable  
PAN AND TILT: Smooth, automatic Pan & Tilt position correction, speed adjustable  
RANGE: Pan-540°, Tilt-270° (16-bit)  
VECTOR MODE: Color+GOBO+Prism+XY Vector  
CONTROL PROTOCOL: DMX 512, 3 pin interface  
CHANNELS: 16/20CH  
DISPLAY: Touch screen, the words can be upside down  
PROTECT GRADE: IP20, overheating & overvoltage protection

### ◎ 技术参数:

额定电压: AC90-240V, 50/60Hz  
光源: 120瓦 LED 白光  
额定功率: 180w  
使用寿命: 50,000小时  
净重: 12.5公斤  
毛重: 15公斤  
灯体尺寸: 长310×宽250×高450 (mm)  
包装尺寸: 长385×宽320×高515 (mm)

### ◎ 性能特点:

光斑角度: 3°  
颜色轮: 10个颜色片+白光, 半色效果, 可做双向变速彩虹效果。  
图案: 固定图案轮: 13个可更换图案片+白光, 可做双向变速效果。  
棱镜: 八棱镜, 双向旋转, 速度可调, 六色效果盘  
调焦: 线性调焦  
雾化: 0%-100%可调  
调光: 0-100%线性调光  
频闪: 0.5-20次/秒, 速度可调  
旋转角度: 水平540°, 垂直270° (自动回位纠错功能, 具有16bit精度调节)  
控制: 国际标准DMX512信号, 3芯接口  
通道: 16CH  
显示: 触摸显示屏, 显示可选倒置  
防护等级: IP20, 内置过热和触发高压保护, LED 温度显示

### ◎ TECHNICAL PARAMETER:

VOLTAGE: AC90- 240V 50/60Hz  
LIGHT SOURCE: 120W LED  
POWER CONSUMPTION: 180W  
NET WEIGHT: 12.5KG  
GROSS WEIGHT: 15KG  
FIXTURE DIMENSION: L310×W250×H450(mm)  
PACKING DIMENSION: L385×W320×H515(mm)

### ◎ PERFORMANCE FEATURE:

BEAM ANGLE: 3°  
1 COLOR WHEEL: 10 colors+open, half color effect, bi-directional rainbow effect at variable speed  
1 FIX GOBO WHEEL: 13 fix gobos+open, bi-directionally rotating at variable speed  
1 PRISM WHEEL: 8-facet prism, bi-directionally rotating, at variable speed, 6 color wheel.  
FOCUS: Linearly adjustable  
DIMMER: 0-100% linearly adjustable  
WASH: 0-100% adjustable  
STROBE: 0.5-20 flash per second, speed adjustable  
PAN AND TILT: Smooth, automatic Pan & Tilt position correction, speed adjustable  
RANGE: Pan-540°, Tilt-270°  
CONTROL PROTOCOL: DMX 512, 3 pin interface  
CHANNELS: 6CH  
DISPLAY: Touch screen, the words can be upside down  
PROTECT GRADE: IP20, overheating & overvoltage protection

## THUNDER-120 LED光束摇头灯



THUNDER-200 DMX Channel Control	
CH1 Pan	0° to 540°
CH2 Tilt	0° to 250°
CH3 Pan Fine	0° to 3.6°
CH4 Tilt Fine	0° to 3°
Ch5 X/Y Speed	Fast to slow
Ch6 Strobe	0 to 241-255
Ch7 Dimmer	0 to 241-255
Ch8 Color	0-14, 15-29, 30-44, 45-59, 60-74, 75-89, 90-104, 110-127, 128-255
Ch9 Color Fine	0° to 3°
Ch10 GOBO	0-14, 15-29, 30-44, 45-59, 60-74, 75-89, 90-104, 110-127, 128-255
Ch11 GOBO	0-14, 15-29, 30-44, 45-59, 60-74, 75-89, 90-104, 110-127, 128-255
Ch12 GOBO Automatic	Stop, 63, 64, 128, 129, 255
Ch13 Prism	0 to 31, 32 to 255
Ch14 Prism Automatic	Stop, 128, 129, 255
Ch15 Atomization	0 to 255
Ch16 zoom	0 to 255
Ch17 Focus	0 to 255
Ch18 Focus Fine	0 to 255
Ch19	NOP
Ch20 Reset	255 Later 2s System Reset

>>光效图

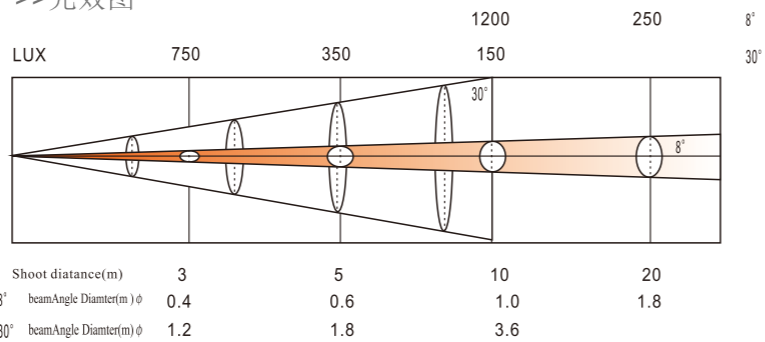

>>光效图

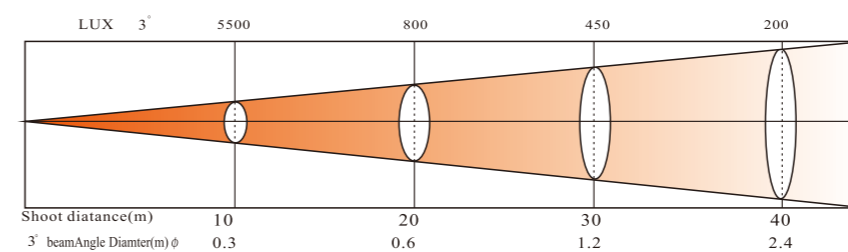

THUNDER-120 DMX Channel Control	
CH1 Pan	0° to 540°
CH2 Tilt	0° to 250°
CH3 Pan Fine	0° to 3.6°
CH4 Tilt Fine	0° to 3°
Ch5 X/Y Speed	Fast to slow
Ch6 Strobe	0 to 241-255
Ch7 Dimmer	0 to 241-255
Ch8 Color	0-7, 8-15, 16-23, 24-31, 32-39, 40-47, 48-55, 56-63, 64-71, 72-79, 80-87, 88-95, 96-103, 104-111, 112-119, 120-127, 128-135, 136-143, 144-151, 152-159, 160-167, 168-175, 176-183, 184-191, 192-199, 200-207, 208-215, 216-223, 224-231, 232-239, 240-247, 248-255
Ch9 6 color	0 to 255
Ch10 GOBO	0-6, 7-13, 14-20, 21-27, 28-34, 35-41, 42-48, 49-55, 56-62, 63-69, 70-76, 77-83, 84-90, 91-97, 98-104, 105-111, 112-118, 119-127, 128-255
Ch11 GOBO shake	0 to 255
Ch12 Prism	0 to 31, 32 to 255
Ch13 Prism rota	0 to 127, 128 to 191, 192 to 255
Ch14 Atomization	0 to 255
Ch15 Focus	0 to 255
Ch16 Reset	255 Later 2s System Reset



## THUNDER-90/60 LED摇头灯



### ◎技术参数:

额定电压: AC90-240V, 50/60Hz  
光源: 90瓦 LED 白光(Thunder-90)  
60瓦 LED白光(Thunder-60)  
额定功率: 180W(Thunder-90)  
150W(Thunder-60)  
使用寿命: 60,000-100,000小时  
净重: 9公斤  
毛重: 10.5公斤  
灯体尺寸: 长362×宽250×高412(mm)  
包装尺寸: 长415×宽345×高425(mm)

### ◎性能特点:

光斑角度: 16°  
颜色轮: 6个颜色片+白光, 半色效果, 可做双向变速彩虹效果。  
图案: 旋转图案轮: 7个可更换图案片+白光, 可做双向变速效果。  
棱镜: 三棱镜, 双向旋转, 速度可调  
调焦: 线性调焦  
调光: 0-100%线性调光  
频闪: 0.5-20次/秒, 速度可调  
旋转角度: 水平540°, 垂直270°  
(自动回位纠错功能, 具有16bit精度调节)  
切光: 具有颜色+图案+棱镜+水平/垂直切光功能  
控制: 国际标准DMX512信号, 3芯接口  
通道: 12CH  
显示: LED数码显示, 显示可选倒置  
防护等级: IP20, 内置过热和触发高压保护

### ◎ TECHNICAL PARAMETER:

VOLTAGE: AC90-240V 50/60Hz  
LIGHT SOURCE: 90W LED(Thunder-90)  
60W LED(Thunder-60)  
POWER CONSUMPTION: 180W(Thunder-90)  
150W(Thunder-60)  
NET WEIGHT: 9KG  
GROSS WEIGHT: 10.5KG  
FIXTURE DIMENSION: L362×W250×H412(mm)  
PACKING DIMENSION: L415×W345×H425(mm)  
RATED LIFE: 60,000-100,000hours

### ◎ PERFORMANCE FEATURE:

BEAM ANGLE: 16°  
1 COLOR WHEEL: 6 colors+open, half color effect, bi-directional rainbow effect at variable speed  
1 ROTATING GOBO WHEEL: 7 rotating gobos+open, bi-directionally rotating at variable speed  
1 PRISM WHEEL: 3-facet prism, bi-directionally rotating, at variable speed  
FOCUS: Linearly adjustable  
DIMMER: 0-100% linearly adjustable  
STROBE: 0.5-20 flash per second, speed adjustable  
PAN AND TILT: Smooth, automatic Pan & Tilt position correction, speed adjustable  
RANGE: Pan-540° Tilt-270° (16-bit)  
VECTOR MODE: Color+GOBO+Prism+XY Vector  
CONTROL PROTOCOL: DMX 512, 3 pin interface  
CHANNELS: 12  
DISPLAY: LED, the words can be upside down  
PROTECT GRADE: IP20, overheating & overvoltage protection

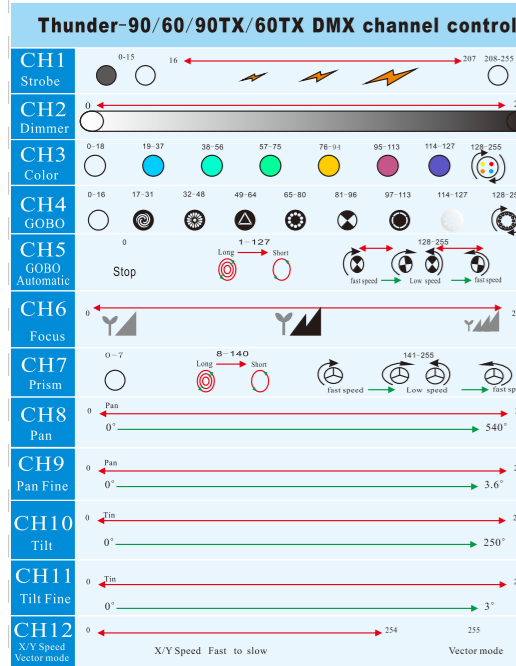

### >>光效图

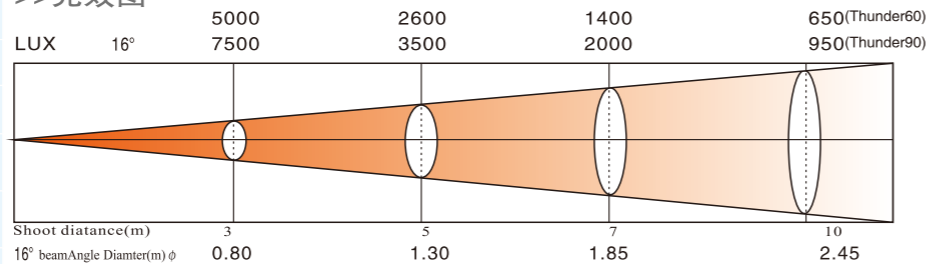

## YLD-190E LED摇头光束灯



### ◎技术参数:

额定电压: AC90-240V, 50/60Hz  
光源: 12瓦\*19颗 四色合一 LED  
额定功率: 300W  
净重: 9公斤  
毛重: 10.5公斤  
灯体尺寸: 长325×宽200×高395(mm)  
包装尺寸: 长390×宽300×高420(mm)  
光斑角度: 5°-50° 可调  
亮度: (6°-6M/8000LUX)  
使用寿命: 60,000-100,000小时  
颜色: 红绿蓝白混色系统  
调光: 0-100%线性调光  
频闪: 0.5-20次/秒, 速度可调  
旋转角度: 水平540°, 垂直270°  
(自动回位纠错功能, 具有16bit精度调节)  
控制: 国际标准DMX512信号, 3芯接口  
通道: 16CH  
显示: LCD液晶显示, 中英文智能操作信息界面  
防护等级: IP20, 内置过热和触发高压保护

### ◎ TECHNICAL PARAMETER:

VOLTAGE: AC90-240V, 50/60Hz  
LED: 12W\*19pcs RGBW LED  
POWER CONSUMPTION: 300W  
BEAM ANGLE: 5°-50° adjustable  
LUMINANCE: (6°-6M/8000LUX)  
RATED LIFE: 60,000-100,000hours  
COLOR MIXING: RGBW  
DIMMER: 0-100% linearly adjustable  
STROBE: 0.5-20 flash per second, speed adjustable  
PAN AND TILT: Smooth, automatic Pan&Tilt position correction, speed adjustable  
RANGE: Pan-540°, Tilt-270° (16-bit)  
CONTROL PROTOCOL: DMX 512, 3 pin interface  
CHANNELS: 16CH  
DISPLAY: LCD display Intelligent operation interface information in English&chinese  
PROTECT GRADE: IP20, overheating & overvoltage protection  
NET WEIGHT: 9KG  
GROSS WEIGHT: 10.5KG  
FIXTURE DIMENSION: L325×W200×H395(mm)  
PACKING DIMENSION: L390×W300×H420(mm)



## YLD-108/YLD-108X LED摇头柔光灯



### ◎技术参数:

额定电压: AC90-240V, 50/60Hz  
光源: 3瓦\*108颗  
(YLD-108红:36;绿:36;蓝:36)  
(YLD-108X红:24;绿:30;蓝:30;白:24)  
额定功率: 360W  
净重: 9公斤  
毛重: 11公斤  
灯体尺寸: 长340×宽240×高440(mm)  
包装尺寸: 长390×宽300×高420(mm)  
光斑角度: 15°-45° (可选)  
使用寿命: 60,000-100,000小时  
调光: 0-100%线性调光  
频闪: 0.5-20次/秒, 速度可调  
旋转角度: 水平540°, 垂直270°  
(自动回位纠错功能, 具有16bit精度调节)  
通道: YLD-108(12CH)YLD-108X(14CH)

### ◎ TECHNICAL PARAMETER:

VOLTAGE: AC90-240V, 50/60Hz  
LED: 3W\*108pcs (YLD-108 R:36; G:36; B:36; W:24)  
POWER CONSUMPTION: 360W  
BEAM ANGLE: 15°-45° (Optional)  
RATED LIFE: 60,000-100,000hours  
DIMMER: 0-100% linearly adjustable  
STROBE: 0.5-20 flash per second, speed adjustable  
PAN AND TILT: Smooth, automatic Pan&Tilt position correction, speed adjustable  
RANGE: Pan-540°, Tilt-270° (16-bit)  
CHANNELS: YLD-108(12CH) YLD-108X(14CH)  
NET WEIGHT: 9KG  
GROSS WEIGHT: 11KG  
FIXTURE DIMENSION: L340×W240×H440(mm)  
PACKING DIMENSION: L395×W315×H460(mm)

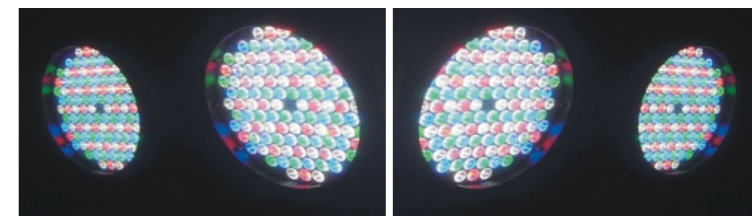

### FS-330 高效追光灯



#### ◎技术参数:

工作电压: AC90-240V 50Hz/60Hz  
光源: 300w led (FS-300)  
YODU MSD 15R (FS-330)  
功率: 350W  
光斑角度: 3° 至 15° 可调  
调焦: 6° 至 15° 可调 (FS-300)  
投射距离: 40-50米  
4种颜色+白光  
轻便, 亮度高 10M/5000LUX  
手动控制, 直观易用  
轴流风扇致冷, 内部优化风路设计, 散热充分良好;  
符合各种安全保护, Ip20保护等级;  
适用于舞台、婚庆、多功能演艺厅及迪斯科等场合。  
灯具尺寸: 长930×宽260×高220 (mm) (FS-330)  
长830×宽260×高220 (mm) (FS-300)  
包装尺寸: 长1030×宽300×高270 (mm)  
净重: 12 公斤  
毛重: 16 公斤

#### ◎ TECHNICAL PARAMETER:

POWER: AC 90-240V 50Hz/60Hz  
LIGHT SOURCE: 300w led (FS-300)  
YODU MSD 15R (FS-330)  
POWER CONSUMPTION: 350W  
Beam angle: 3° - 15° adjustable  
ZOOM: 6° - 15° adjustable (FS-300)  
Cast distance: 40-50M  
4colors+open  
Lightweight, high brightness 10/5000LUX  
Manual control, easily use  
Convection cooling-fan, optimize internal air duct way, heat elimination rapidly  
According to various kinds of safety standards, IP20, protect grade  
As well as the stage, multi-functional studio and disco, wedding ceremony.  
FIXTURE DIMENSION: L930×W260×H220 (mm) (FS-330)  
L830×W260×H220 (mm) (FS-300)  
PACKING DIMENSION: L1030×W300×H270 (mm)  
NET WEIGHT: 12KG  
GROSS WEIGHT: 16KG

### FS-300 LED追光灯



#### >>光效图

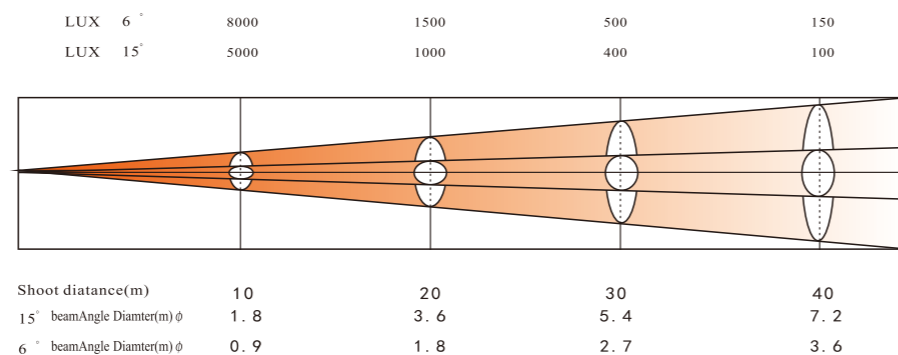

### SHANOW-330-300

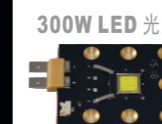
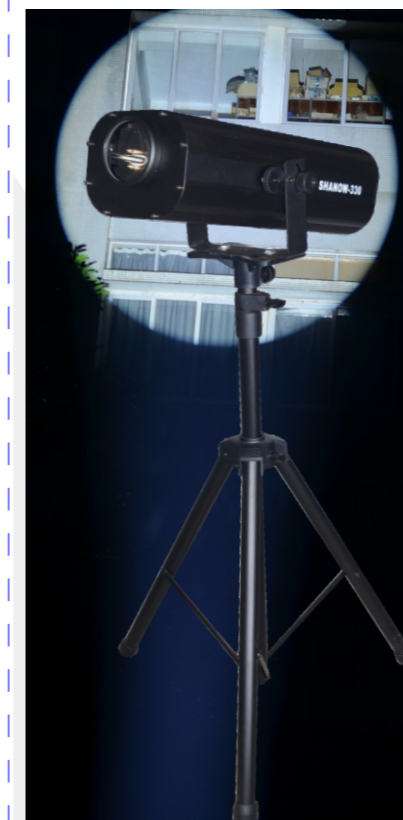

### 300w Mini led follow light brighter than 1200w halide follow light 300w 迷你LED追光灯亮度超过传统1200w 金属卤化物灯追光灯

#### ◎技术参数:

工作电压: AC90-240V 50Hz/60Hz  
光源: 300W led  
功率: 380W  
光斑角度: 3° 至 15° 可调  
投射距离: 30-40米  
轻便, 亮度高  
4种颜色+白光  
手动控制, 直观易用  
轴流风扇致冷, 内部优化风路设计, 散热充分良好;  
符合各种安全保护, Ip20保护等级;  
适用于舞台、婚庆、多功能演艺厅及迪斯科等场合。  
灯具尺寸: 长560×宽260×高180 (mm)  
包装尺寸: 长610×宽290×高240 (mm)  
净重: 9 公斤  
毛重: 11公斤

#### ◎ TECHNICAL PARAMETER:

POWER: AC 90-240V 50Hz/60Hz  
LIGHT SOURCE: 300W led  
POWER CONSUMPTION: 380W  
Beam angle: 3° - 15° adjustable  
Cast distance: 30-40M  
Lightweight, high brightness  
4colors+open  
Manual control, easily use  
Convection cooling-fan, optimize internal air duct way, heat elimination rapidly  
According to various kinds of safety standards, IP20 protect grade  
As well as the stage, multi-functional studio and disco, wedding ceremony.  
FIXTURE DIMENSION: L560×W260×H180 (mm)  
PACKING DIMENSION: L610×W290×H240 (mm)  
NET WEIGHT: 9KG  
GROSS WEIGHT: 11KG

#### >>光效图

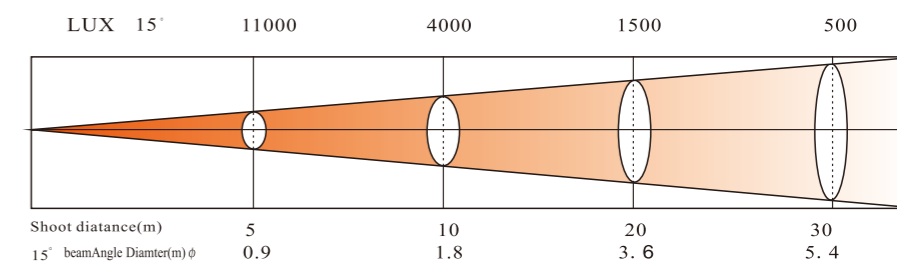

### SHANOW-330A

#### 电子追光灯



#### ◎技术参数:

工作电压: AC90-240V 50Hz/60Hz  
光源: OSRAM 7R  
功率: 280W  
频闪: 1-20次/秒  
投射距离: 30-40 米  
亮度6M/7000LUX中心亮度  
电子调焦;  
光圈: 10%-100%可调  
4种颜色+白光, 彩虹效果  
频闪, 开合光一体化设计;  
控制面板按键, 直观易用;  
轴流风扇致冷, 内部优化风路设计, 散热充分良好;  
符合各种安全保护, Ip20保护等级;  
适用于广告宣传、婚庆、多功能演艺厅及迪斯科等场合。  
灯具尺寸: 长660×宽240×高180 (mm)  
包装尺寸: 长720×宽295×高245 (mm)  
净重: 9 公斤  
毛重: 11公斤

#### ◎ TECHNICAL PARAMETER:

POWER: AC 220V 50Hz/60Hz  
LIGHT SOURCE: OSRAM 7R  
POWER CONSUMPTION: 280W  
STROBE: 1-20time/second  
Cast distance: 30-40M  
brightness 6M/7000LUX  
electronic focus  
TUNE LIGHT: 10-100% mechanic unlimited adjusted  
4colors+open, rainbow effect  
Strobe effect and integration design  
Key and push-pull switch integration, easily use  
Convection cooling-fan, optimize internal air duct way, heat elimination rapidly  
According to various kinds of safety standards, IP20 protect grade  
As well as the multi-functional studio and disco, wedding ceremony.  
FIXTURE DIMENSION: L660×W240×H180 (mm)  
PACKING DIMENSION: L720×W295×H245 (mm)  
NET WEIGHT: 9KG  
GROSS WEIGHT: 11KG



2 Meter Led Flame Lights

**TX-1000/TX-1000PRO**

2.5米 LED火焰灯



◎ 技术参数:

工作电压: AC200-240V 50Hz/60Hz  
光源: 36X3W (72X3W TX-1000PRO)  
RGB 3合一 LED  
功率: 350W (450W TX-1000PRO)  
频闪: 1-20次/秒  
19个标准DMX512通道  
火焰高度: 2米 (2.5米 TX-1000P[R0])  
火焰宽度: 0.9米  
特点: 多彩火焰效果, 梦幻火焰颜色动感变化, 颜色变化, 速度可调, 颜色设有频闪功能  
控制模式: 遥控模式, DMX512信号模式, 主从控制模式(多台同步)带自走程序  
工作环境: 室内0°C-40°C  
预计使用寿命: 10000小时  
符合各种安全保护, Ip20保护等级;  
适用于舞台、广告宣传、展览会等场合  
灯具尺寸: 长1120×宽300×高340 (mm)  
包装尺寸: 长1200×宽410×高440 (mm)  
净重: 25公斤  
毛重: 28公斤

◎ TECHNICAL PARAMETER:

POWER: AC 200-240V 50Hz/60Hz  
LIGHT SOURCE: 36x3w (72x3w TX-1000PRO)  
RGB 3IN1 LED  
POWER CONSUMPTION: 350W (450W TX-1000PRO)  
STROBE: 1-20time/second  
19standard DMX512 channels  
Flame height 2M (2.5M TX-1000PRO)  
Flame width 0.9M  
Feature: colorful flame effect, fire color,adjustable, Flash,Built-in programs  
Control Mode: telecontrol mode, DMX512 signal control mode, master-slave control mode (Multiple simultaneous) procedures with self-propelled  
Working environment:indoor 0°C -40°C  
Expected useful life;10000hours  
According to various kinds of safety standards, IP20 protect grade  
As well as the stage, exhibition ,advertising.  
FIXTURE DIMENSION: L1120x300x340(mm)  
PACKING DIMENSION: L1200x410x440(mm)  
NET WEIGHT: 25KG  
GROSS WEIGHT: 28KG

◎ 技术参数:

工作电压: AC200-240V 50Hz/60Hz  
光源: 72X3W RGB 3合一 LED  
功率: 400W  
频闪: 1-20次/秒  
14个标准DMX512通道  
火焰高度: 2.5米  
特点: 圆型立体火焰效果, 梦幻火焰颜色动感变化, 颜色变化, 速度可调, 颜色设有频闪功能  
控制模式: 遥控模式, DMX512信号模式, 主从控制模式(多台同步)带自走程序  
工作环境: 室内0°C-40°C  
预计使用寿命: 10000小时  
符合各种安全保护, Ip20保护等级;  
适用于舞台、广告宣传、展览会、多功能演艺厅及迪斯科等场合。  
灯具尺寸: 长620×宽620×高370 (mm)  
包装尺寸: 长680×宽680×高440 (mm)  
净重: 25公斤  
毛重: 28公斤

◎ TECHNICAL PARAMETER:

POWER: AC 200-240V 50Hz/60Hz  
LIGHT SOURCE: 72x3w RGB 3IN1 LED  
POWER CONSUMPTION: 400W  
STROBE: 1-20time/second  
14standard DMX512 channels  
Flame height 2.5M  
Feature: Circles 3D flame effect, fantastic fire color,adjustable, Flash,Built-in programs  
Control Mode: telecontrol mode, DMX512 signal control mode, master-slave control mode (Multiple simultaneous) procedures with self-propelled  
Working environment:indoor 0°C -40°C  
Expected useful life;10000hours  
According to various kinds of safety standards, IP20 protect grade  
As well as the stage,multi-functional studio and disco, exhibition ,advertising.  
FIXTURE DIMENSION: L620x350x290(mm)  
PACKING DIMENSION: L400x400x340(mm)  
NET WEIGHT: 25KG  
GROSS WEIGHT: 28KG

3D Led Flame Lights

**TX-2000**

2.5米立体梦幻LED火焰灯



同步自动运行连接图



无线系统连接图 1



3D Led Flame Lights

**TX-200**

立体LED火焰灯

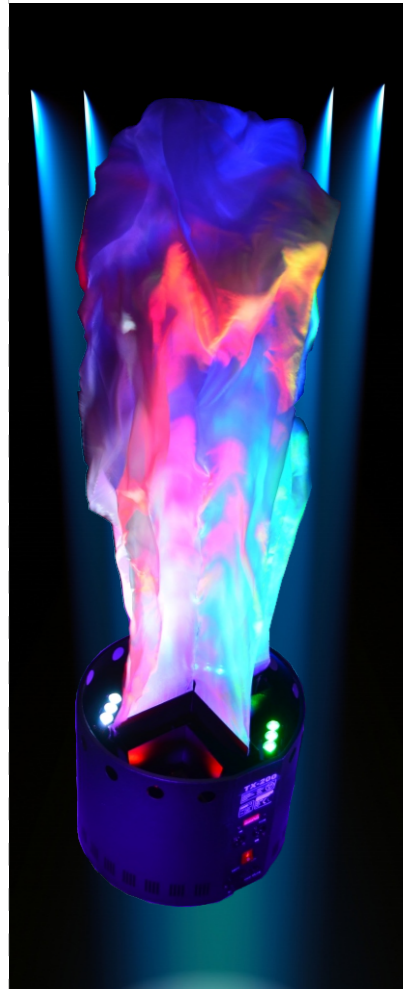

◎技术参数:

工作电压: AC200-240V 50Hz/60Hz  
光源: 12X3W RGB 3合一 LED  
功率: 100W  
频闪: 1-20次/秒  
14个标准DMX512通道  
火焰高度: 1米  
特点: 立体火焰效果, 梦幻火焰颜色动感变化, 颜色变化, 速度可调, 颜色设有频闪功能  
控制模式: 遥控模式, DMX512信号模式, 主从控制模式(多台同步)带自走程序  
工作环境: 室内0°C-40°C  
预计使用寿命: 10000小时  
符合各种安全保护, Ip20保护等级;  
适用于舞台、婚庆、多功能演艺厅及迪斯科等场合。  
灯具尺寸: 长350×宽350×高290(mm)  
包装尺寸: 长400×宽400×高340(mm)  
净重: 8公斤  
毛重: 9公斤

◎ TECHNICAL PARAMETER:

POWER: AC 200-240V 50Hz/60Hz  
LIGHT SOURCE: 12x3w RGB 3IN1 LED  
POWER CONSUMPTION: 100W  
STROBE: 1-20time/second  
14standard DMX512 channels  
Flame height: 1M  
Feature: 3D flame effect, fantastic fire color, adjustable, Flash, Built-in programs  
Control Mode: telecontrol mode, DMX512 signal control mode, master-slave control mode (Multiple simultaneous) procedures with self-propelled  
Working environment: indoor 0°C-40°C  
Expected useful life: 10000hours  
According to various kinds of safety standards, IP20 protect grade  
As well as the stage, multi-functional studio and disco, wedding ceremony.  
FIXTURE DIMENSION: L350×350×290(mm)  
PACKING DIMENSION: L400×400×340(mm)  
NET WEIGHT: 8KG  
GROSS WEIGHT: 9KG

无线系统连接图 2



REMOTE CONTROLLER

MASTER

SLAVE

SLAVE

SLAVE

SLAVE

◎技术参数:

工作电压: AC200-240V 50Hz/60Hz  
功率: 20W  
特点: 内置8个程序, 可定做不同图案变化的程序。  
控制模式: DMX512信号模式, 可控25台TX-200火焰灯, 每灯可不同变化。  
工作环境: 室内0°C-40°C  
适用于舞台、广告宣传、展览会、多功能演艺厅及迪斯科等场合。  
灯具尺寸: 长305×宽170×高75 (mm)  
包装尺寸: 长360×宽220×高120 (mm)  
净重: 1.5公斤  
毛重: 3公斤

◎ TECHNICAL PARAMETER:

POWER: AC 200-240V 50Hz/60Hz  
POWER CONSUMPTION: 20W  
Feature: Built-in 8 programs, can be customized different program with different design  
Control Mode: DMX512 signal control mode, control 25 pcs TX-200  
Working environment: indoor 0°C-40°C  
As well as the stage, multi-functional studio and disco, exhibition, advertising.  
FIXTURE DIMENSION: L305x170x75mm  
PACKING DIMENSION: L360x220x120(mm)  
NET WEIGHT: 1.5KG  
GROSS WEIGHT: 3KG



LED FLAME LAMP CONTROLLER

**TC-200**

LED火焰灯控制器

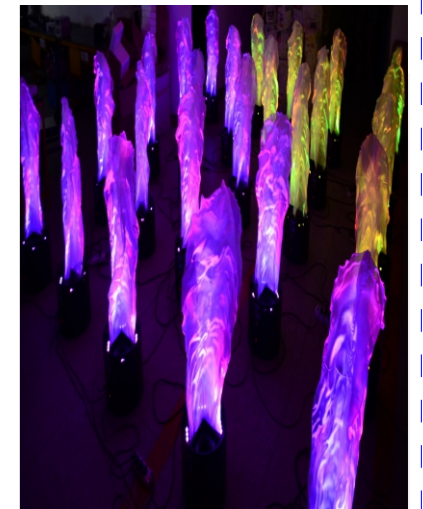

控制台系统连接图

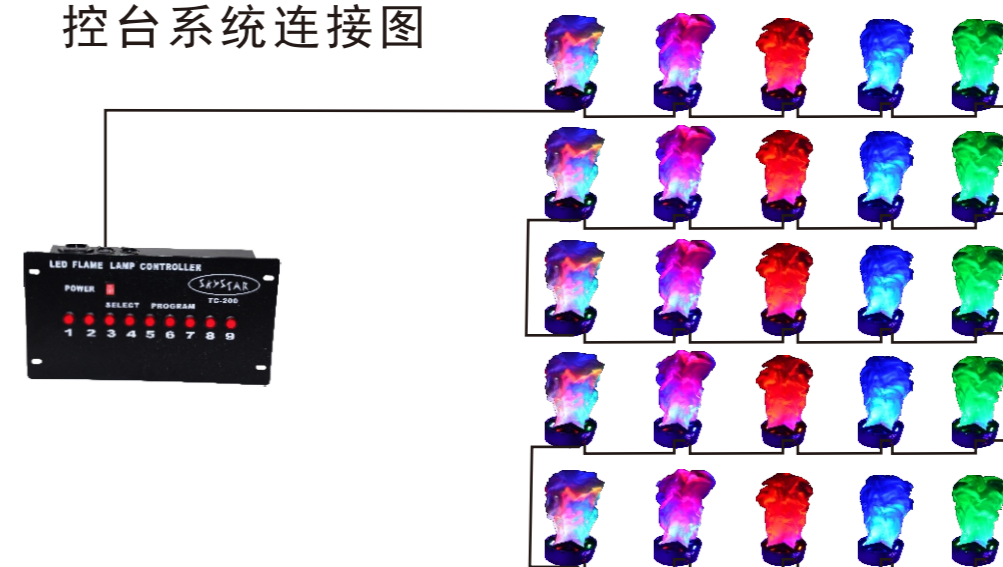

3D Led Flame Lights

TX-100

LED火焰灯

◎技术参数:

工作电压: AC90-240V 50Hz/60Hz  
光源: 12X3W LED  
红=4颗, 蓝=4颗, 绿=4颗  
功率: 120W  
频闪: 1-20次/秒  
6个标准DMX512通道  
特点: 多种火焰颜色动感变化, 颜色变化速度可调, 颜色设有频闪功能  
控制模式: 遥控模式, DMX512信号模式, 主从控制模式(多台同步)带自走程序  
工作环境: 室内-20°C-40°C  
预计使用寿命: 10000小时  
符合各种安全保护, Ip20保护等级;  
适用于舞台、婚庆、多功能演艺厅及迪斯科等场合。  
灯具尺寸: 长530×宽265×高335 (mm)  
包装尺寸: 长590×宽330×高400 (mm)  
净重: 11 公斤  
毛重: 13公斤

◎ TECHNICAL PARAMETER:

POWER: AC 90-240V 50Hz/60Hz  
LIGHT SOURCE: 12x3w LED R4, B4, G4  
POWER CONSUMPTION: 120W  
STROBE: 1-20time/second  
6standard DMX512 channels  
Feature: 3different fire color, adjustable, Flash, Built-in programs  
Control Mode: telecontrol mode, DMX512 signal control mode, master-slave control mode (Multiple simultaneous) procedures with self-propelled  
Working environment: indoor -20°C-40°C  
Expected useful life: 10000hours  
According to various kinds of safety standards, IP20 protect grade  
As well as the stage, multi-functional studio and disco, wedding ceremony.  
FIXTURE DIMENSION: L530×265×335(mm)  
PACKING DIMENSION: L590×330×400(mm)  
NET WEIGHT: 11KG  
GROSS WEIGHT: 13KG

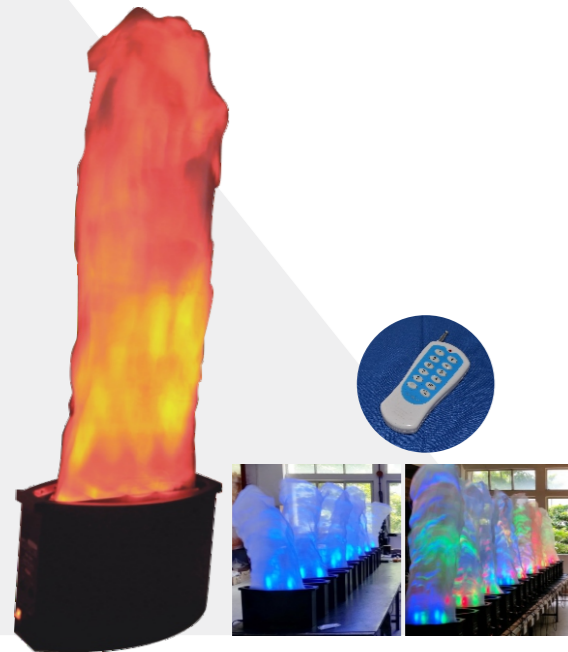

TX-500

LED火焰灯

◎技术参数:

工作电压: AC200-240V 50Hz/60Hz  
光源: 20X3W RGB 3合一 LED  
功率: 200W  
频闪: 1-20次/秒  
16个标准DMX512通道  
火焰高度: 1.5米  
火焰宽度: 0.6米  
特点: 多彩火焰效果, 梦幻火焰颜色动感变化, 颜色变化, 速度可调, 颜色设有频闪功能  
控制模式: 遥控模式, DMX512信号模式, 主从控制模式(多台同步)带自走程序  
工作环境: 室内0°C-40°C  
预计使用寿命: 10000小时  
符合各种安全保护, Ip20保护等级;  
适用于舞台、广告宣传、展览会等场合  
灯具尺寸: 长710×宽300×高340 (mm)  
包装尺寸: 长780×宽370×高440 (mm)  
净重: 15公斤  
毛重: 17公斤

◎ TECHNICAL PARAMETER:

POWER: AC 200-240V 50Hz/60Hz  
LIGHT SOURCE: 20x3w RGB 3IN1 LED  
POWER CONSUMPTION: 200W  
STROBE: 1-20time/second  
16standard DMX512 channels  
Flame height 1.5M  
Flame width 0.6M  
Feature: colorful flame effect, fire color, adjustable, Flash, Built-in programs  
Control Mode: telecontrol mode, DMX512 signal control mode, master-slave control mode (Multiple simultaneous) procedures with self-propelled  
Working environment: indoor 0°C -40°C  
Expected useful life: 10000hours  
According to various kinds of safety standards, IP20 protect grade  
As well as the stage, exhibition ,advertising.  
FIXTURE DIMENSION: L710x300x340(mm)  
PACKING DIMENSION: L780x370x440(mm)  
NET WEIGHT: 15KG  
GROSS WEIGHT: 17KG



◎技术参数:

工作电压: AC200-240V 50Hz/60Hz  
光源: 36X3W RGB 3合一 LED  
功率: 200W  
频闪: 1-20次/秒  
14个标准DMX512通道  
火焰高度: 1.5米  
特点: 圆型立体火焰效果, 梦幻火焰颜色动感变化, 颜色变化, 速度可调, 颜色设有频闪功能  
控制模式: 遥控模式, DMX512信号模式, 主从控制模式(多台同步)带自走程序  
工作环境: 室内0°C-40°C  
预计使用寿命: 10000小时  
符合各种安全保护, Ip20保护等级;  
适用于舞台、广告宣传、展览会、多功能演艺厅及迪斯科等场合。  
灯具尺寸: 长440×宽440×高360 (mm)  
包装尺寸: 长490×宽490×高410 (mm)  
净重: 12公斤  
毛重: 14公斤

◎ TECHNICAL PARAMETER:

POWER: AC 200-240V 50Hz/60Hz  
LIGHT SOURCE: 36x3w RGB 3IN1 LED  
POWER CONSUMPTION: 200W  
STROBE: 1-20time/second  
14standard DMX512 channels  
Flame height: 1.5M  
Feature: Circles 3D flame effect, fantastic fire color, adjustable, Flash, Built-in programs  
Control Mode: telecontrol mode, DMX512 signal control mode, master-slave control mode (Multiple simultaneous) procedures with self-propelled  
Working environment: indoor 0°C-40°C  
Expected useful life: 10000hours  
According to various kinds of safety standards, IP20 protect grade  
As well as the stage, multi-functional studio and disco, exhibition ,advertising.  
FIXTURE DIMENSION: L350 × 350 × 290 (mm)  
PACKING DIMENSION: L400 × 400 × 340 (mm)  
NET WEIGHT: 12KG  
GROSS WEIGHT: 14KG

立体梦幻LED火焰灯



无线系统连接图 3



### FM-100

#### LED大功率投光灯



#### ◎技术参数:

电 压: 90~240V AC, 50~60Hz  
功 率: 130W  
灯 珠: 100W COB  
2个标准DMX512通道  
颜 色: 4500K白光  
多种频闪: 1~25次/秒  
(常规频闪, 雷电频闪, 随机频闪, 突暗渐亮频闪, 突亮渐暗频闪)线性调节  
控制模式: DMX512信号控制模式, 主从控制模式(多台同步)带自走程序  
电子调光0~100%线性调节  
显 示 板: LED显示面板  
冷却方式: 风扇冷却  
保护措施: 过流、过压、温保  
预计使用寿命: 50000个小时  
外观尺寸: 长230×宽260×高300mm  
包装尺寸: 长250×宽250×高360mm  
净 重: 3kg  
毛 重: 4kg  
灯 体: 铸铝+塑胶

#### ◎ TECHNICAL PARAMETER:

Voltage: 90 ~ 240V AC, 50 ~ 60Hz  
Power: 130W  
Lamp beads: 100W COB  
2standard DMX512 channels  
Color: 4500K white  
A variety of Flash: 1 ~ 25 times / sec (conventional strobe, lightning flash, random Strobe, strobe light suddenly getting dark, sudden dimming strobe light) linear regulator  
Control Mode: DMX512 signal control mode, master-slave control mode (Multiple simultaneous) procedures withself-propelled  
Electronic dimming from 0 to 100% linear regulator  
Display panel: LED display panel  
Cooling: Fan cooling  
Protection: over current, over voltage, temperature and security  
Expected useful life: 50,000 hours  
DIMENSIONS: L230x260 x 300mm  
PACKING SIZE:L250 x250 x360mm  
Net weight: 3kg  
Gross weight: 4kg  
Lamp body: aluminum

### WED-90

#### LED防水投光灯



#### ◎技术参数:

电 压: 90~240V AC, 50~60Hz  
额定功率: 180W  
光源功率: 18x8W 4合一  
防水等级: IP65  
预计使用寿命: ≥50000个小时  
控制通道: 7CH标准DMX512通道控制  
连接数量: 一个连路可连接20台。  
控制模式: DMX512信号控制模式, 主从控制模式(多台同步)带自走程序  
保护功能: 过压、过流、温保自动复位功能  
环境温度: -18°C~38°C  
工作温升: 10°C~35°C  
颜 色: 颜色可任意调节变化, 有颜色流水功能, 速度快慢可调  
调 光: 0~100%电子调光, 各颜色可以单独或是混合调光  
频 闪: 1~25次/秒高速频闪, 可以单色, 混色温频闪  
显 示 板: LED显示面板  
冷却方式: 机体自动散热  
外观尺寸: 长260×宽230×高190mm  
包装尺寸: 长250×宽250×高360mm  
净 重: 4kg  
毛 重: 5kg

#### ◎ TECHNICAL PARAMETER:

VOLTAGE: 90 ~ 240V AC, 50 ~ 60Hz  
POWER: 300W/500W  
POWER OF LIGHT SOURCE: 90x 3W/5W LED R = 20, G = 24, B = 24, W = 22  
WATERPROOF GRADE: Ip65  
EXPECTED SERVICE LIFE: 50000 hours  
CONTROL CHANNEL: 7CH standard DMX512 channel control  
THE MUMBER OF CONNECTIONS: one line can be conncted to 20  
CONTROL MODE: DMX512 signal control mode, master-slave control mode (Multiple simultaneous) procedures withself-propelled  
Protective function of overvoltage, overcurrent, Wen Bao: automatic reset function  
AMBIENT TEMPERATURE:-18°C~38°C  
WORKING TEMPERATURE:10°C~35°C  
COLOR: any color can be adjusted the color change, water features, speed can be adjusted  
DIMMING: 0-100% electronic dimming, various colors can be alone or mixed light modulation  
STROBE: 1-25 / s high-speed stroboscopic, can be monochromatic, mixed color temperature light  
DISPLAY PANEL: LED display panel  
COOLING MEANS: automatic radiating body  
DIMENSIONS: L260 x 230 x 190mm  
PACKING SIZE:L250x W250 x H360mm  
N.W:4kg  
G.W:5kg

### HLD-24M

#### LED全彩Par灯



#### ◎技术参数:

电 压: 90~240V AC, 50~60Hz  
功 率: 220W  
灯 珠: 24X8W RGBW 4合1  
光学透镜: 标准25° 可选15°、30°、45°、60°  
8个标准DMX512通道  
颜 色: 1670万种颜色变化, 有颜色流水功能, 速度快慢可调  
频 闪: 1~20次/秒线性调节  
控制模式: DMX512信号控制模式, 主从控制模式(多台同步)带自走程序  
电子调光: 0~100%线性调节  
显 示 板: LED显示面板  
冷却方式: 风扇冷却  
保护措施: 过流、过压、温保  
预计使用寿命: 50000个小时  
外观尺寸: 长230×宽260×高300mm  
包装尺寸: 长250×宽250×高360mm  
净 重: 3.8kg  
毛 重: 4.5kg  
灯 体: 铸铝

#### ◎ TECHNICAL PARAMETER:

Voltage: 90 ~ 240V AC, 50 ~ 60Hz  
Power: 220W  
Lamp beads:24X8W RGBW four in one  
Optical lens: standard 25°optional 15°, 30°, 45°,60°  
8standard DMX512 channels  
Color: 1670 kinds of colors, colored water features, speed Level speed adjustable  
A variety of Flash: 1 ~ 20 times / sec linear regulator  
Control Mode: DMX512 signal control mode, master-slave control mode (Multiple simultaneous) procedures with self-propelled  
Electronic dimming from 0 to 100% linear regulator  
Display panel: LED display panel  
Cooling: Fan cooling  
Protection: over current, over voltage, temperature and security  
Expected useful life: 50,000 hours  
DIMENSIONS: L230x260 x300mm  
PACKING SIZE:L250xW250 xH360mm  
Net weight: 3.8kg  
Gross weight: 4.5kg  
Lamp body: aluminum

### WED-54

#### LED防水投光灯



#### ◎技术参数:

电 压: 90~240V AC, 50~60Hz  
额定功率: 180W  
光源功率: 54x3W LED 红=14颗, 绿=14颗, 蓝=14颗, 白=12颗  
防水等级: IP65  
预计使用寿命: ≥50000个小时  
控制通道: 7CH标准DMX512通道控制  
连接数量: 一个连路可连接32台。  
控制模式: DMX512信号控制模式, 颜色: 颜色可任意调节变化, 有颜色流水功能, 速度快慢可调  
调 光: 0~100%电子调光, 各颜色可以单独或是混合调光  
频 闪: 1~25次/秒高速频闪, 可以单色, 混色温频闪  
冷却方式: 机体自动散热  
外观尺寸: 长270×宽270×高300mm  
包装尺寸: 长270×宽290×高320mm  
净 重: 7.5kg  
毛 重: 8kg

#### ◎ TECHNICAL PARAMETER:

VOLTAGE: 90 ~ 240V AC, 50 ~ 60Hz  
Power: 180W  
Power of light source: 54 x 3W LED R = 14, G = 14, B = 14, W = 12  
Waterproof grade: Ip65  
Expected service life: 50000 hours  
Control channel: 7CH standard DMX512 channel control  
The number of connections: one line can be conncted to 32  
CONTROL MODE: DMX512 signal control mode, Color: any color can be adjusted the color change, water features, speed can be adjusted  
Dimming: 0-100% electronic dimming, various colors can be alone or mixed light modulation  
Strobe: 1-25 / s high-speed stroboscopic, can be monochromatic, mixed color temperature light  
Cooling means: automatic radiating body  
DIMENSIONS: L270x270x300mm  
PACKING SIZE:L270x290x320mm  
N.W: 7.5kg  
G.W:8kg

### HLD-54M/54/36

#### LED Par灯



#### ◎技术参数:

电 压: 90~240V AC, 50~60Hz  
功 率: 180W (HLD-54/54M) 120W (HLD-36)  
灯 珠: 54X 2W 三合一 (HLD-54M) 54X 3W (HLD-54) 红=18颗, 绿=18颗, 蓝=18颗 36X 3W (HLD-36) 红=12颗, 绿=12颗, 蓝=12颗  
光学透镜: 标准25° 可选15°、30°、45°、60°  
7个标准DMX512通道  
颜 色: 1670万种颜色变化, 有颜色流水功能  
频 闪: 1~20次/秒线性调节  
控制模式: DMX512信号控制模式, 主从控制模式(多台同步)带自走程序  
电子调光: 0~100%线性调节  
显 示 板: LED显示面板  
冷却方式: 风扇冷却  
保护措施: 过流、过压、温保  
预计使用寿命: 50000个小时  
外观尺寸: 长230×宽260×高300mm  
包装尺寸: 长250×宽250×高360mm  
净 重: 3.8kg  
毛 重: 4.5kg  
灯 体: 铸铝

#### ◎ TECHNICAL PARAMETER:

Voltage: 90 ~ 240V AC, 50 ~ 60Hz  
Power: 180W(HLD-54/54M)120W(HLD-36)  
Lamp beads: 3IN1(HLE-54M) R18+G18+B18 X3W (HLD-54) R12+G12+B12 X3W (HLD-36)  
Optical lens: standard 25° ,optional 15° , 30° ,45° ,60°  
7standard DMX512 channels  
Color: 1670 kinds of colors, colored water features.  
A variety of Flash: 1 ~ 20 times / sec linear regulator  
Control Mode: DMX512 signal control mode, master-slave control mode (Multiple simultaneous) procedures with self-propelled  
Electronic dimming from 0 to 100% linear regulator  
Display panel: LED display panel  
Cooling: Fan cooling  
Protection: over current, over voltage, useful life: 50,000 hours  
DIMENSIONS: L230 x 260 x 300mm  
PACKING SIZE:L250 x W250 x H360mm  
Net weight: 3.8kg  
Gross weight: 4.5kg  
Lamp body: aluminum

### WED-24M

#### 防水洗墙灯



#### ◎技术参数:

电 压: 90~240V AC, 50~60Hz  
功 率: 100W  
灯 珠: 24X3W RGB 3合1  
光学透镜: 标准25° 可选15°、30°、45°、60°  
防水等级: IP65  
控制通道: 7和3个标准DMX512通道  
颜 色: 1670万种颜色变化, 有颜色流水功能, 速度快慢可调  
频 闪: 1~20次/秒线性调节  
控制模式: DMX512信号控制模式, 电子调光: 0~100%线性调节  
冷却方式: 机体自动散热  
预计使用寿命: 50000个小时  
外观尺寸: 长1000×宽70×高90mm  
包装尺寸: 长1050×宽90×高120mm  
净 重: 8kg  
毛 重: 9kg  
灯 体: 铝

#### ◎ TECHNICAL PARAMETER:

Voltage: 90 ~ 240V AC, 50 ~ 60Hz  
Power: 100W  
Lamp beads:24X3W RGB 3 in 1  
Optical lens: standard 25° optional 15°, 30°,45°,60°  
WATERPROOF GRADE: Ip65  
Control channel: 7&3standard DMX512 channels  
Color: 1670 kinds of colors, colored water features, speed Level speed adjustable  
A variety of Flash: 1 ~ 20 times / sec linear regulator  
Control Mode: DMX512 signal control mode, Electronic dimming from 0 to 100% linear regulator  
Cooling: automatic radiating body  
Expected useful life: 50,000 hours  
DIMENSIONS: L1000xW70 xH90mm  
PACKING SIZE:L1050x W90 x H120mm  
Net weight: 8kg  
Gross weight: 9kg  
Lamp body: aluminum